



User Manual v1.42 build 1014

Overview

SDRuno is an advanced Software Defined Radio application platform which is optimized for use with the SDRplay range of Radio Spectrum Processing receivers. This means that the specific features of a particular SDRplay RSP receiver model are enabled automatically within SDRuno.

Release Version

Please note that if a SDRuno release has a build number after it, that this represents a build of the relevant SDRuno release and NOT the final release for that version number. For example, v1.42 build 0720 is not the last v1.42 release, but a particular build of v1.42



Table of Contents

1 - Installation	6
2 - SDRuno Panels	11
2.1 Main	11
2.1.1 Main Panel Settings	12
2.2 RX Control (RX)	16
2.2.1 RX Control Settings	17
2.3 Main SP (SP1)	21
2.3.1 Main SP Settings	22
2.4 Scanner	22
2.5 EX Control	23
2.6 Scheduler & Recorder	24
2.6.1 Scheduler Event Editor	25
2.6.2 Scheduler Example 1	26
2.6.3 Scheduler Example 2	30
2.7 Memory Panel	33
2.8 Aux SP (SP2)	34
2.8.1 Aux SP Settings	34
2.9 RDS Info	35
2.10 Plugins	36
3 - Getting Started	37
3.1 Application instance	37
3.2 Resetting SDRuno	38
3.2.1 Backup and restore SDRuno	38
3.3 SDRplay RSP devices	39
3.4 Starting the RSP stream	41
3.4.1 Startup Tips	42
3.5 Selecting an output device	43
3.6 Setting the RX frequency	43
3.7 Step Size	44
3.8 Entering frequency directly	44
3.9 Workspace	45
3.9.1 Auto Layout	45
3.10 Managing Workspaces	46
3.11 Minimize/Restore All option	46
3.12 Temporary LO Lock	47
3.13 Frequency calibration	47
3.14 Keyboard shortcuts	48
4 - SDRuno Functions	49

4.1 Status Bar	49
4.2 Zoom	49
4.3 VFO	50
4.4 Resolution bandwidth	50
4.5 The spectrum “quick browser”	51
4.6 SP2 filter adjustments	51
4.6.1 Asymmetrical adjustment	52
4.6.2 Pass band Tuning	52
4.6.3 CW pitch (CW shift)	53
4.7 Adjusting the proportion of spectrum and waterfall displays	53
4.8 Aux Spectrum Display	54
4.9 VRX	54
4.9.1 Adding and removing a VRX.	55
5 - Scanning	55
5.1 Scanning a list of frequencies (Memory Scan)	57
5.2 Range Scan	58
5.3 Custom Range Scan	59
5.4 Scanner Statistics	60
6 - IQ Audio Output	62
7 - Audio Limiters	62
8 - IF AGC controls	63
9 - PWR & SNR to CSV	64
10 - Automatic Band Framing	65
10.1 – Band Framing Customization	66
11 - Other SDRuno Features and Functions	67
11.1 Synchronous AM	67
11.2 S-Meter function	69
11.3 Quick notch frequency setting and the notch-lock function	69
11.4 RDS	70
12 - Memory Panel	72
12.1 Basic concepts	72
12.2 The memory bank file format	73
12.3 GUI items for memory banks management	73
12.4 The “Memory” Panel	74
12.5 Memory data fields	75
12.6 The data grid	76
12.6.1 Customizing the columns order	76
12.6.2 Manual editing of cells	77
12.6.3 Manually inserting a new row	77

12.6.4 Deleting a row	78
12.6.5 Moving a row.....	78
12.6.6 Copying a row	78
12.6.7 Copying a single cell.....	79
12.6.8 Advanced editing operations	79
12.6.9 Selecting and copying multiple cells	80
12.7 Bank file operations	80
12.7.1 Changing the current Banks Folder.....	80
12.7.2 Opening a bank file.....	80
12.7.3 Saving a bank	81
12.7.4 Saving a bank with a specific name.....	81
12.7.5 Creating a new empty bank.....	81
12.7.6 Searching the memory bank.....	82
12.8 Recalling a memory location.....	82
12.9 Storing to a memory location	83
12.10 Importing from other database formats.....	83
12.11 Creating a composite bank from several source banks.....	84
12.12 Deleting banks	84
12.13 Filtering data	84
12.14 Profiles	85
13 - IQ Recording	86
13.1 Playback of IQ Recording	87
13.2 Quick recording.....	87
13.3 Using multiple VRX while playing IQ files.....	88
13.4 Scheduled IQ recorder.....	89
14 - Using the custom controls.....	90
14.1 Sliders	90
14.2 Wheel Edit Dials.....	90
14.3 The I/O Sample Rate difference issue.....	91
14.4 Setting to allow for external front end gain or loss.....	91
15 - External up/down converters offset.....	92
15.1 Changing a converter frequency offset.....	92
15.2 Enabling a converter offset	92
15.3 Disable any active offset.....	92
15.4 Inverted spectrum mode	93
16 - IF Output Mode	94
17 - CAT	95
17.1 How SDRuno implements CAT	96
17.2 VRX CAT parameters	102

17.3 COM Device.....	102
17.4 Baud Rate	102
17.5 RX Mode CTRL.....	102
17.6 Enable & Connect	102
17.7 Example: connecting to Ham Radio Deluxe	102
18 - SDRuno as the controlling device – Omnirig	103
18.1 Omnirig installation and set-up	103
18.2 How SDRuno handles Omnirig.....	103
18.3 Monitoring Omnirig status from SDRuno instance #0	104
18.4 Which parameters are synchronized?	104
18.5 Omnirig related VRX options	104
18.6 RIG Selection.....	104
18.7 SYNC VRX->RIG	105
18.8 SYNC RIG->VRX.....	105
18.9 SYNC Centre FREQ. (LO).....	105
18.10 SYNC RX Mode	105
18.11 The RSYN button.....	105
19 - Tmate and Tmate 2 Controllers	106
19.1 The Tmate server.....	106
19.2 Tmate server options	106
19.3 Enable Server	106
19.4 Auto Assign.....	107
19.5 Tmate 2.....	107
19.6 Tmate 2 Uses the VRX background	108
19.7 Tmate Controller	109
19.8 Tmate-2 Controller	110
20 - Abbreviations and Acronyms	112
21 - Appendix 1 Using the RSPduo with SDRuno.	114
22 - Appendix 2 RSPdx's HDR mode usage.....	124
23 - Troubleshooting.....	125
24 - Quick Start Guide	126
25 - Legal Information.....	129



It may be necessary to temporarily disable your Antivirus software to allow the installation to install uninterrupted. **Remember to reenable your Antivirus after installation.**

1 - Installation

Download the SDRuno installer from the SDRplay website (<https://www.sdrplay.com/sdruno> as shown below) or from our Downloads page (<https://www.sdrplay.com/downloads>)



The SDRuno Roadmap can be found [here](#) and the SDRuno user manual can be found [here](#)

If you are new to SDRuno please watch [this short video](#) before scrolling down to the Download button

SDRuno® is a registered trade mark of SDRplay

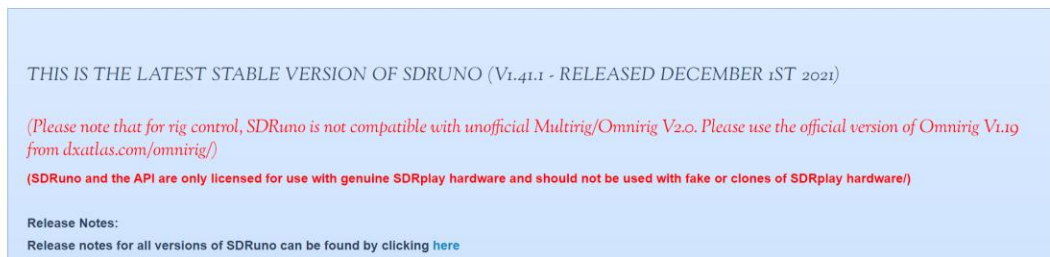

Run the downloaded installation file and you will see this, click Yes to continue.

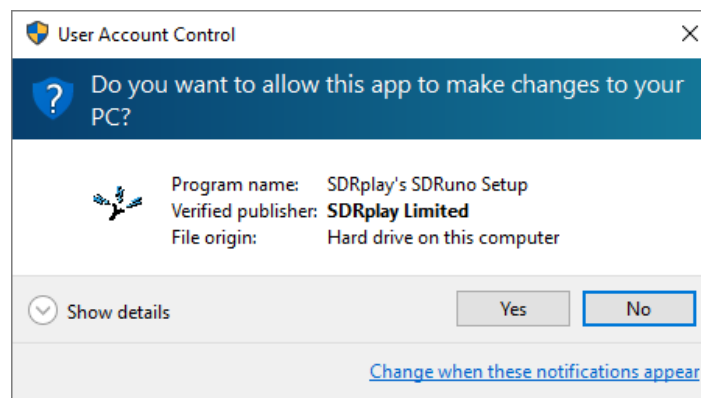

Please read and accept the license agreement.

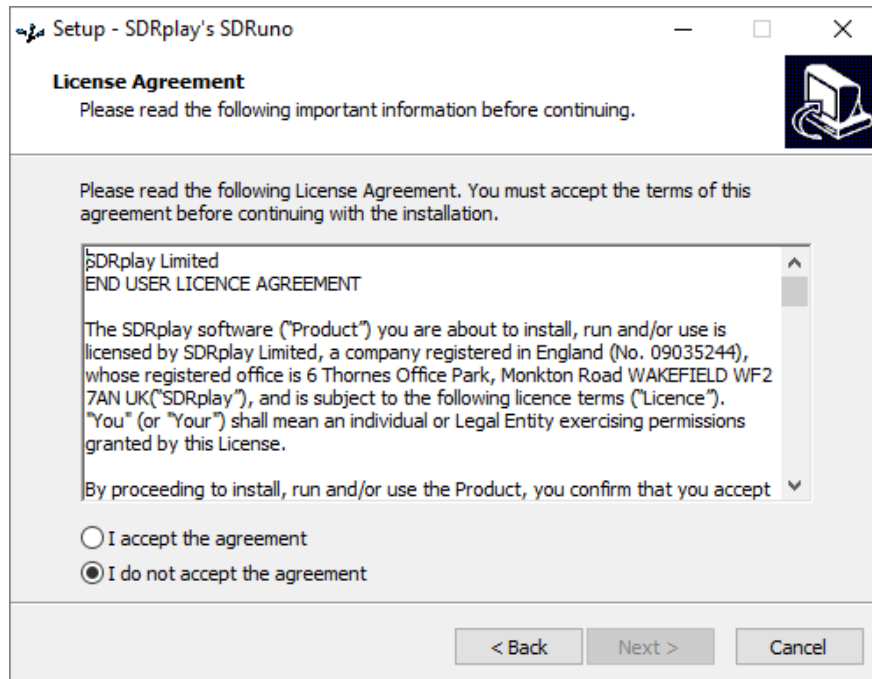

The next screen will display important information. Read and then click Next.

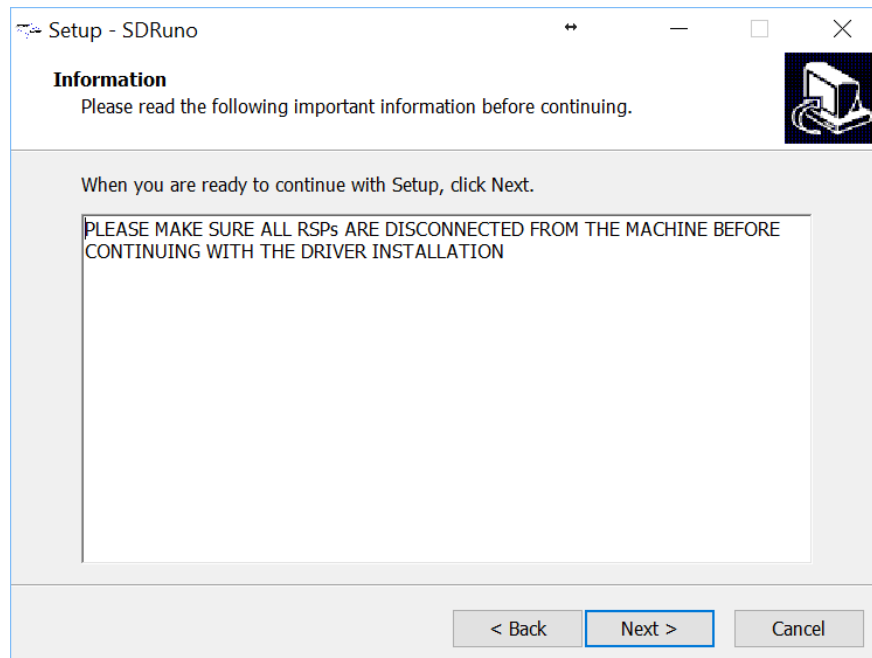

The next screen displays the installation directory. Check that you have enough disk space and then click Next

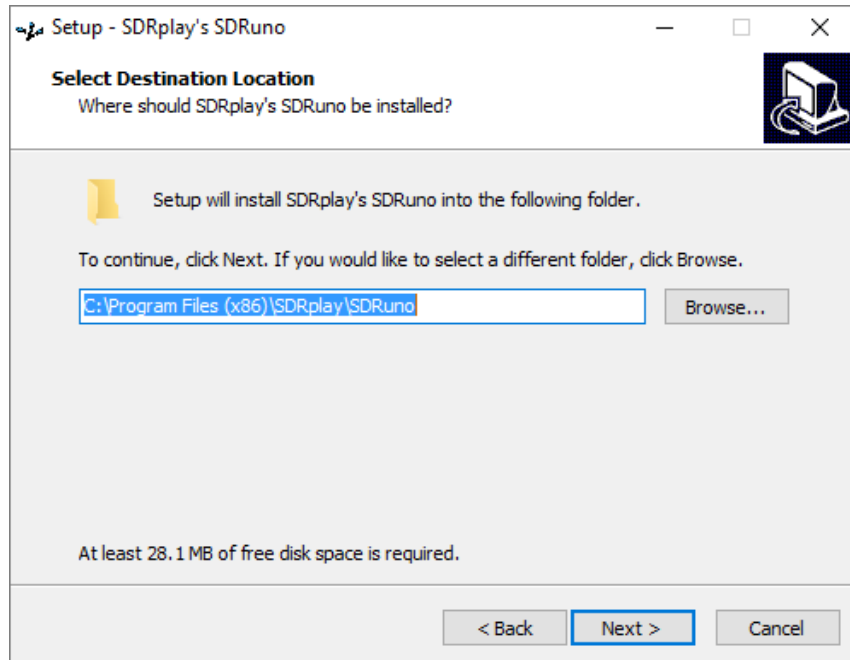

If a previous version of SDRuno already exists the installer will remove it before installing this version.

The next screen allows the Start Menu folder to be changed if needed.

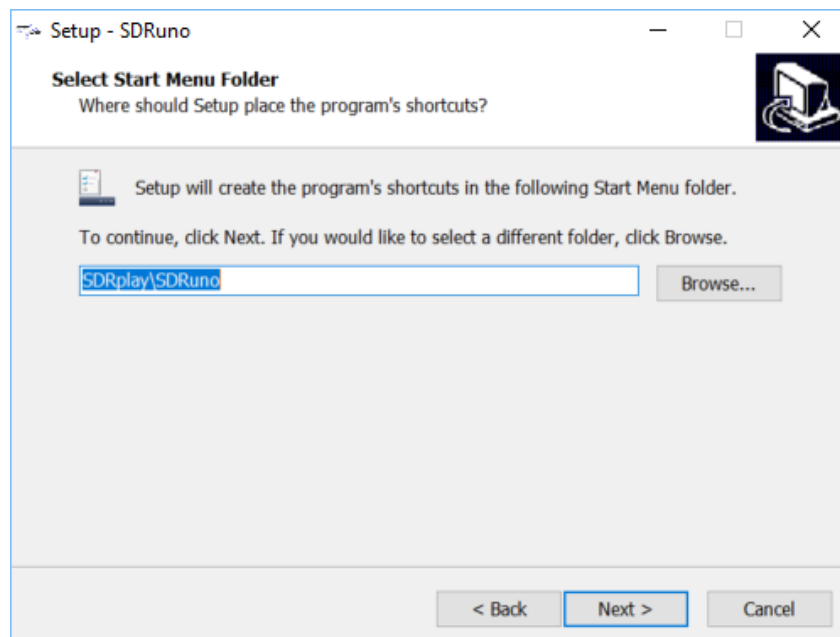

The next screen confirms where the software will be installed to. If correct, click Install.

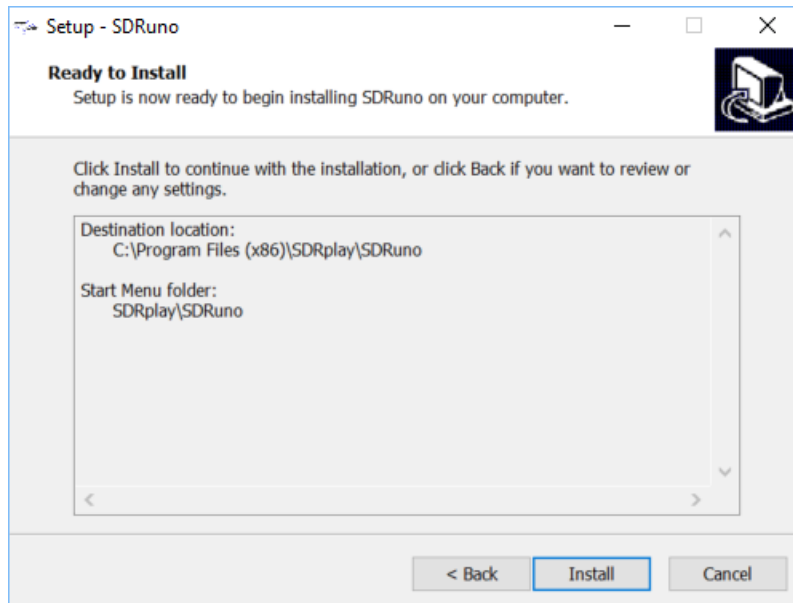

Check the next window for important information about installing the hardware drivers.

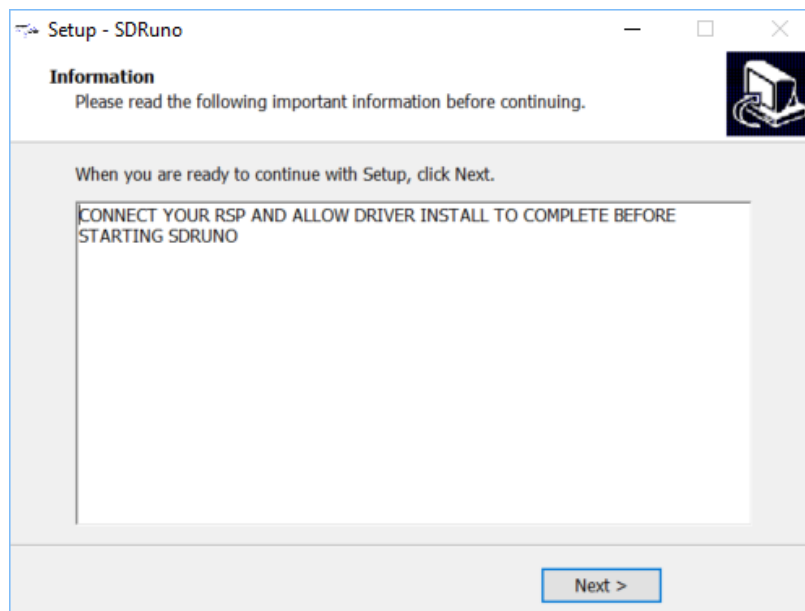

This completes the installation. Clicking Next will close the installer. Now connect the RSP(s) and wait for the hardware driver(s) to install before starting SDRRuno.

SDRuno Known Issues

- SP2 CWAFC drift issue (Zoom/window size/freq display).
- If SDRuno is running when graphics scaling is changed, the memory panel text may turn black. Restarting SDRuno will fix this.
- If the zoom has been used in VRX0, a graphical issue in the SP1 display can occur if a mode button is pressed in another VRX. Zooming out and in again will fix it.

Note: The known issues will be addressed prior to the final 1.42 release.



DO NOT directly connect an RSP to the same antenna as your transmitter, or to an antenna in the near field of a transmitting antenna, as this is likely to result in irreversible damage to your RSP. Simply unplugging the USB cable from the RSP does not protect it from possible damage.

<https://www.sdrplay.com/wp-content/uploads/2017/10/171011PanadapterGuide.pdf>

Technical Support

To streamline support requests and better serve you, we utilize a support ticket system. Every support request is assigned a unique ticket number which you can use to track the progress and responses online.

For your reference we provide complete archives and history of all your support requests. A valid email address is required to submit a ticket.

Additional Resources

SDRplay website.

<https://www.sdrplay.com>

SDRplay online support.

<https://www.sdrplay.com/help>

SDRplay online App/Note catalogue.

<https://www.sdrplay.com/apps-catalogue/>

SDRuno release notes.

https://www.sdrplay.com/docs/SDRplay_SDRuno_Release_Notes.pdf

2 - SDRuno Panels

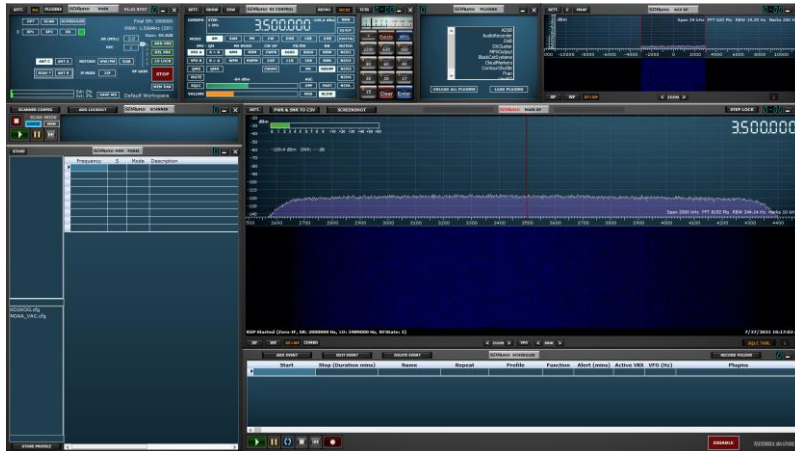

2.1 Main



Different RSP buttons will appear depending on which RSP is being controlled by this instance of SDRuno (the image above is using the RSPdx). These can be seen in section [3.3](#)

- SETT:** Displays the "MAIN" settings panel.
- PLUGINS:** Displays the "PLUGINS" panel.
- MA:** Enables the minimize & maximize all feature of displayed panels.
- 0:** Specifies what SDRuno instance is in use.
- OPT:** Displays additional SDRuno functions.
- SCANNER:** Displays the "SCANNER" panel.
- SCHEDULER:** Displays the "SCHEDULER & RECORDING" panel.
- SP1:** Displays the "MAIN SP" panel.
- SP2:** Displays the "AUX SP" panel.
- RX:** Displays the "RX CONTROL" panel.
- SR:** Sets the RSP input sample rate (**Not visible when a band framing button is in use**)
- DEC:** Sets the decimation value of the sample rate (**Not visible when a band framing button is in use**)
- IF MODE:** Switch between the IF modes (from Low IF to Zero IF mode and vice-versa).
- ADD VRX:** Adds a VRX.
- DEL VRX:** Deletes the last added VRX.
- LO LOCK:** Locks the LO
- PLAY/STOP:** Starts and Stops the SDRuno stream.
- MEM PAN:** Displays the "MEMORY" panel.
- Sdr:** The total percentage of CPU resource that is taken by SDRuno
- Sys:** The total CPU resource being used across all applications on your PC.
- WORKSPACES:** Displays available workspaces.
- SAVE WS:** Saves the current workspace.
- RF GAIN:** Increases or decreases the RSP low-noise preamplifier.
- IFAGC DISABLED:** If this message appears, the IF AGC has been turned off in the Main Panel Settings
- USB: BULK:** If this message appears, USB BULK Transfer mode has been selected in the Main Panel Settings
- OVERLOAD:** If this message appears, it is simply a warning to indicate that the RF/IF gain needs to be reduced.

2.1.1 Main Panel Settings

INPUT

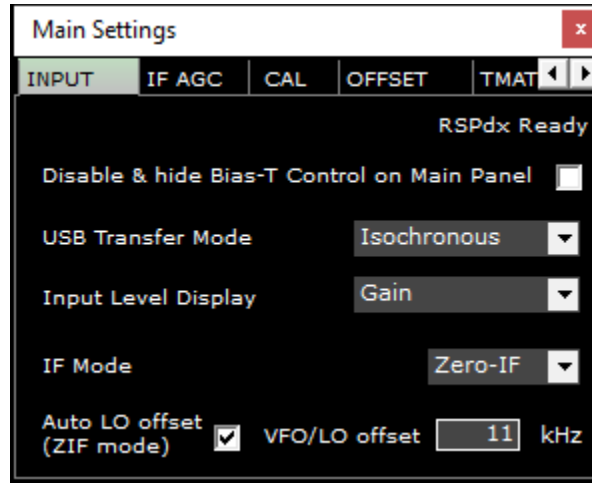

Disable & hide Bias-T Control: Disables and hides the Bias-T function in the Main panel.

USB Transfer Mode: Specifies the RSP USB data transfer mode. Isochronous mode should be used unless the computing platform does not provide support for isochronous mode, in which case Bulk mode should be used. Isochronous mode guarantees the highest possible USB bandwidth and minimum latency. This setting can be changed at any time but will only take effect the next time the stream is stopped and then started again. If bulk mode is selected, USB:BULK will be displayed on the Main panel.

Input Level Display: Changes the MAIN panel RF slider from gain to attenuation.

IF Mode: Sets the tuner into Zero IF mode or Low IF mode.

Auto LO offset (ZIF mode): Enables an AUTO LO offset when the RSP is in ZERO IF mode.

VFO/LO offset: Sets the separation range between the VFO and the LO when auto LO offset is on .

IF AGC

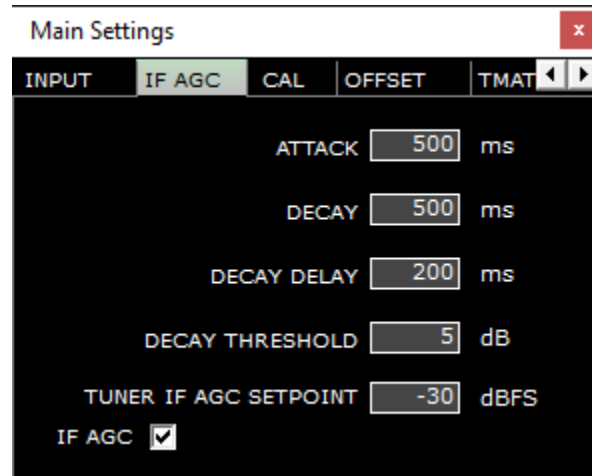

Attack: Time taken for the AGC to reach 95% of the target value after an increase in the signal power.

Decay: Time taken for the AGC to reach 95% of the target value after a reduction in the signal power.

Decay Delay: Time after the power levels has reduced by an amount \geq to the decay threshold, before the AGC loop starts the decay process.

Decay Threshold: Amount by which the power level must fall before the decay delay timer is activated.

Tuner IF AGC Setpoint: Sets the target level power at which AGC routine will attempt adjust the power into the ADC input.

IF AGC: Enables automatic IF AGC or manual control of the RSP. IF AGC is enabled by default. If IF AGC is turn off AGC DISABLED will be displayed on the Main panel.

CAL

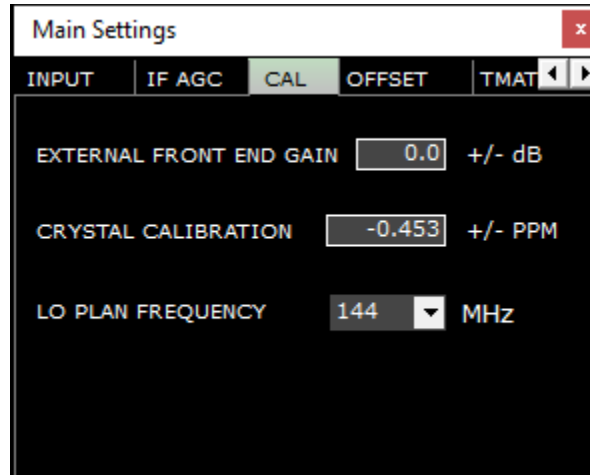

External Front End Gain: Adjusts for any losses or gains in either coax cables or pre-amps etc.

Crystal Calibration: Allows trimming of the reference crystal frequency to adjust errors in absolute frequency.

LO Plan Frequency: Sets the LO frequency that is applied to the RSP block converter.

OFFSET

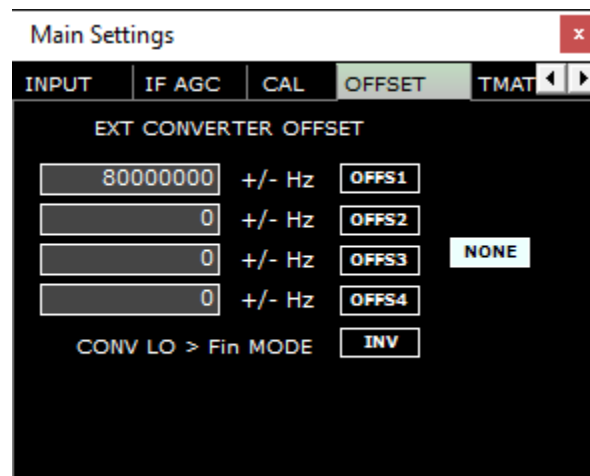

OFFS1-S4: Enables or disables the selected entered offsets.

CONV LO > Fin Mode: Select this option if your LO frequency is greater than your input frequency.

NONE: Disables the use of any external up/down frequency conversion entered in OFFS1 – OFFS4.

TMATE

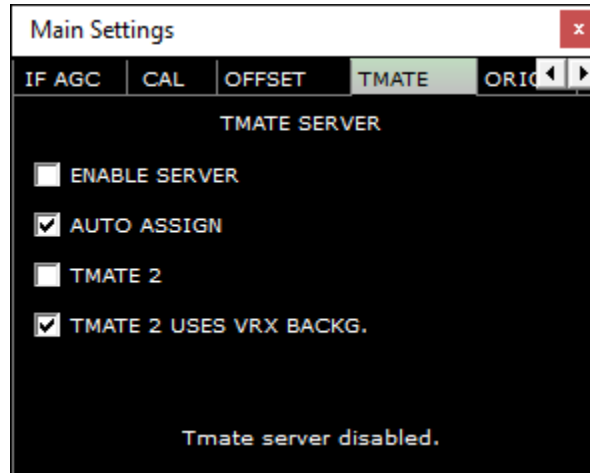

Enable Server: Starts or stops the TMATE communication server.

Auto Assign: Choose between two “assigning” options for the Tmate controller.

Tmate2: Checked selects the TM2 controller, uncheck selects the TM1 controller.

Tmate2 uses VRX backg: Applies the current VRX background color to the TM2 LCD display color.

ORIG

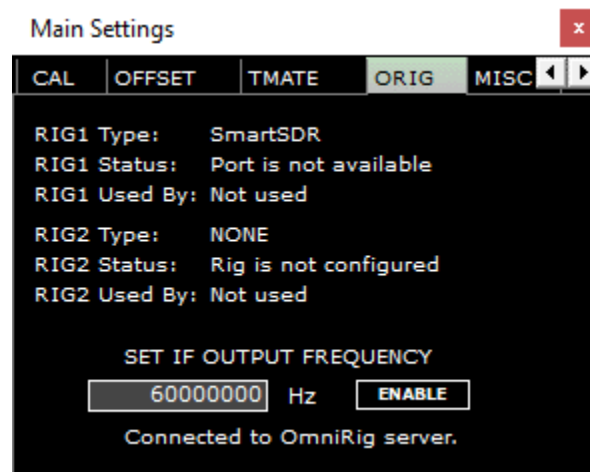

Set IF output frequency: Enables a user configured external IF input frequency (Hz).

MISC

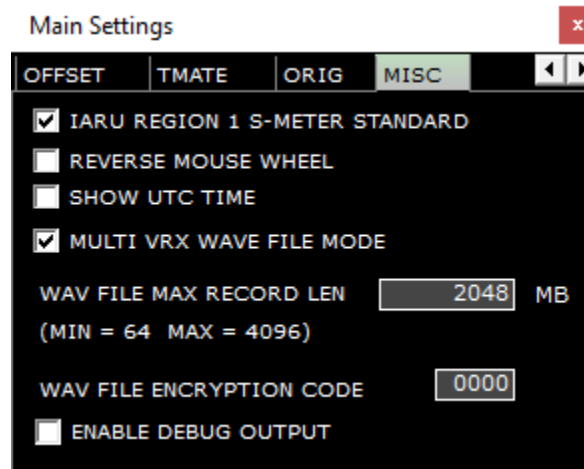

IARU region 1 S-Meter standard: Checked S9 = -73 dBm up to 30 MHz and S9 = -93 dBm for frequencies above 30 MHz .

Reverse mouse wheel: Changes the direction of mouse wheel actions. This is global in SDRuno.

Show time in UTC: Displays time in UTC vs standard time in the Status bar and Scheduler.

Multi VRX wave file mode: - When enabled multi-VRXs can access the same recorded IQ file.

WAV file encryption code: - Sets the embedded encryption code used in SDRuno IQ recordings. 0000 is unencrypted.

Enable debug output: - Enables debug output to the status Bar.

2.2 RX Control (RX)



SETT: Displays the “RX CONTROL” settings panel.

RDSW: Displays the “RDS” data panel.

EXW: Displays the “EX CONTROL” panel.

RSYN1: Enables external application OMNIRIG for rig control to be used for this specific VRX.

MCTR: Enables memory tuning from the MEM. Panel to be used for this specific VRX.

TCTR: Enables T-Mate controller to be used for this specific VRX.

0-00: 00 denotes what VRX is in use, the leading 0 specifies what SDRuno instance is in use.

RMS: Sets the S-Meter mode (Toggles between RMS and Peak) – Note: ALWAYS use RMS mode for accurate signal power measurements.

AM: Amplitude Modulation. Sub bandwidth filter sizes can be selected.

SAM: Synchronous AM. Sub bandwidth filter sizes can be selected.

FM: Frequency modulation. Sub bandwidth filter sizes can be selected.

CW: Continuous wave. Sub bandwidth filter sizes can be selected.

DSB: Double sideband. Sub bandwidth filter sizes can be selected.

LSB: Lower sideband. Sub bandwidth filter sizes can be selected.

USB: Upper sideband. Sub bandwidth filter sizes can be selected.

DIGITAL: Disables internal AF filtering. Used for decoding applications. Sub bandwidth filter sizes can be selected.

IQ OUT: IQ output up to 192 kHz to the selected Audio Output device.

FREQUENCY DISPLAY: Displays the current tuned frequency, step size and signal power level in dBm. Right clicking the display will allow you to change the tuning step size per mode.

VFO A: Selects VFO A.

VFO B: Selects VFO B.

A>B: Copies VFO A frequency to VFO B.

B>A: Copies VFO B frequency to VFO A.

QMS: Quick memory save.

QMR: Quick memory recall.

MUTE: Mutes the audio output.

SQLC: Enables squelch. The squelch slider setting in VRX0 is also the scanner threshold (for both memory and range scans). The exception is in a memory scan, you can also specify a per frequency threshold in the memory panel that will override this setting.

VOLUME: Adjusts the AF output via the orange slider.

NFM: Changes the FM sub mode to Narrow FM.

MFM: Changes the FM sub mode to Medium FM.

WFM: Changes the FM sub mode to Wide FM.

SWFM: Changes the FM sub mode to Stereo wide FM.

CWPK: Enables the CW PEAK filter. Adjustable via the EX CONTROL panel.

ZAP: Selects the strongest signal in AUX SP filter bandwidth.

CWAF: CW automatic frequency control.

NR: Enables noise reduction. Adjustable via the EX CONTROL panel.

NBW: Noise blanker wide. Adjustable via the EX CONTROL panel.

NBN: Noise blanker narrow. Adjustable via the EX CONTROL panel.

NBOFF: Disables the noise blanker.

AGC OFF: Turns the automatic gain control to off.

AGC MED: Sets the audio automatic gain control to medium.

AGC FAST: Sets the audio automatic gain control to fast.

AGC SLOW: Sets the audio automatic gain control to slow.

NCH1-4: Enables notch filter 1-4. Adjustable via the EX CONTROL panel.

NCHL: Locks the notch filters.

BANDS: Allows selection of predetermined framed bands.

2.2.1 RX Control Settings

AGC

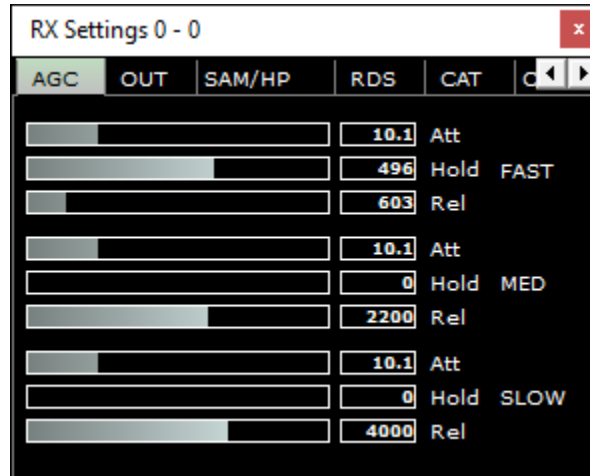

Fast: Default parameters for Fast audio AGC.

Med: Default parameters for Med audio AGC.

Slow: Default parameters for Slow audio AGC.

Att: Audio AGC attack time in milliseconds.

Hold: Audio AGC hold time in milliseconds.

Rel: Audio AGC release time in milliseconds.

OUT

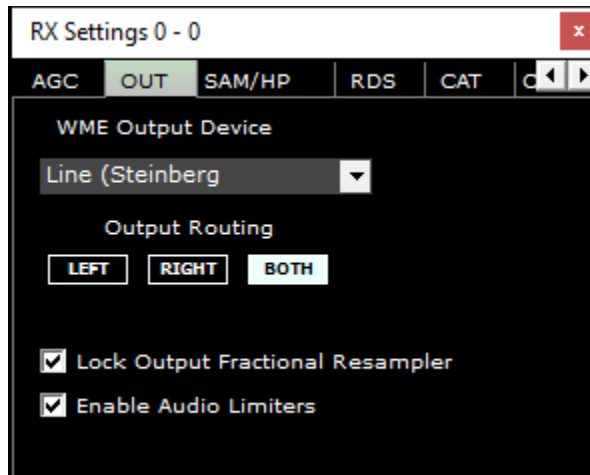

WME Output device: Selects the systems primary playback device (soundcard).

Output routing: Selects the channel to route demodulated audio.

Lock output fractional Resampler: Enables or disables memory buffers that dampen audio sample rate differences.

Enable audio limiters: Enables or disables SDRuno demodulated audio limiters.

SAM/HP

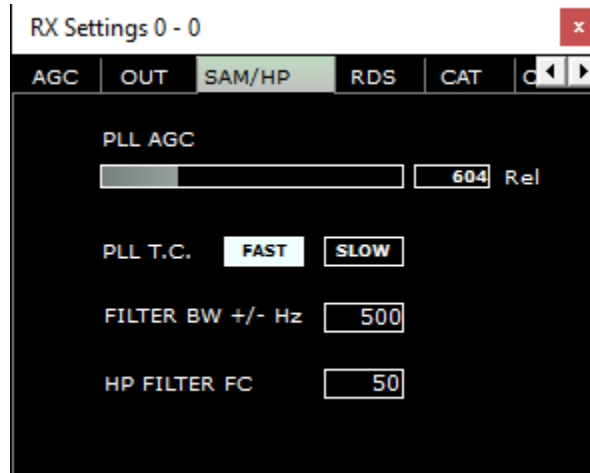

- PLL AGC:** Adjusts the phase lock loop automatic gain control.
- PLL T.C. :** Selects the phase lock loop step response.
- Filter BW +/- Hz:** Adjusts the phase lock loop passband filter.
- HP filter FC:** Adjusts the high pass filter frequency cut off value.

RDS

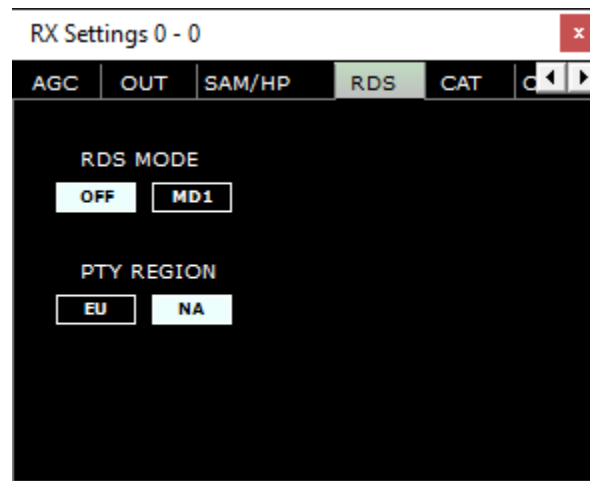

- RDS Mode:** Enables or disables the RDS decoder.
- PTY Region:** Selects the decoded program type region.

CAT

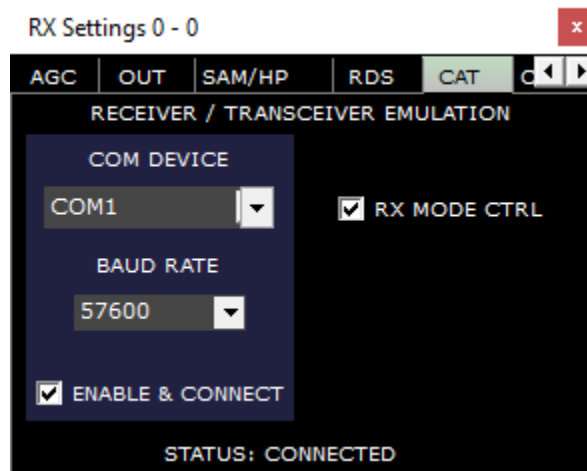

COM Device: Selects an available valid com port present in the system.

Baud Rate: Sets the selected com ports baud rate.

Enable and Connect: Enables or disables the selected com port.

RX Mode CTRL: Synchronises the current mode selected.

Status: Displays com port connection status.

ORIG

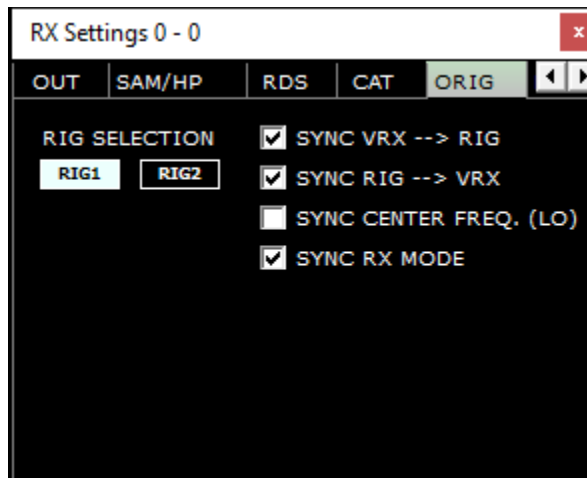

RIG Selection: Selects one of two available pre-configured omnirig rig profiles.

Sync VRX -> RIG: Synchronises the current VRX frequency to the transceiver.

Sync RIG -> VRX: Synchronises the current transceiver frequency to the current VRX.

Sync Center FREQ. (LO) : Synchronises the center local oscillator frequency.

Sync RX mode: Synchronises the current mode selected.

MISC

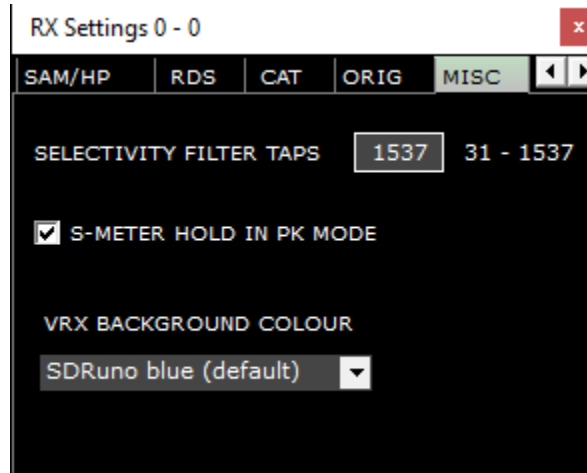

Selectivity filter taps: Sets the number of taps used in the digital filtering chain length.

S-Meter hold in PK mode: When enabled, the S-meter holds the peak value when peak mode is selected rather than RMS.

VRX background color: Selects a predefined SDRuno color theme.

CAL

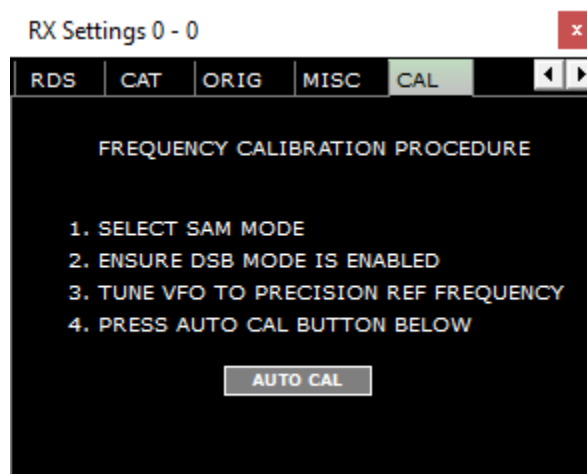

Auto CAL: Calibrates the RSP against a reference signal whose frequency is known and accurate.

2.3 Main SP (SP1)

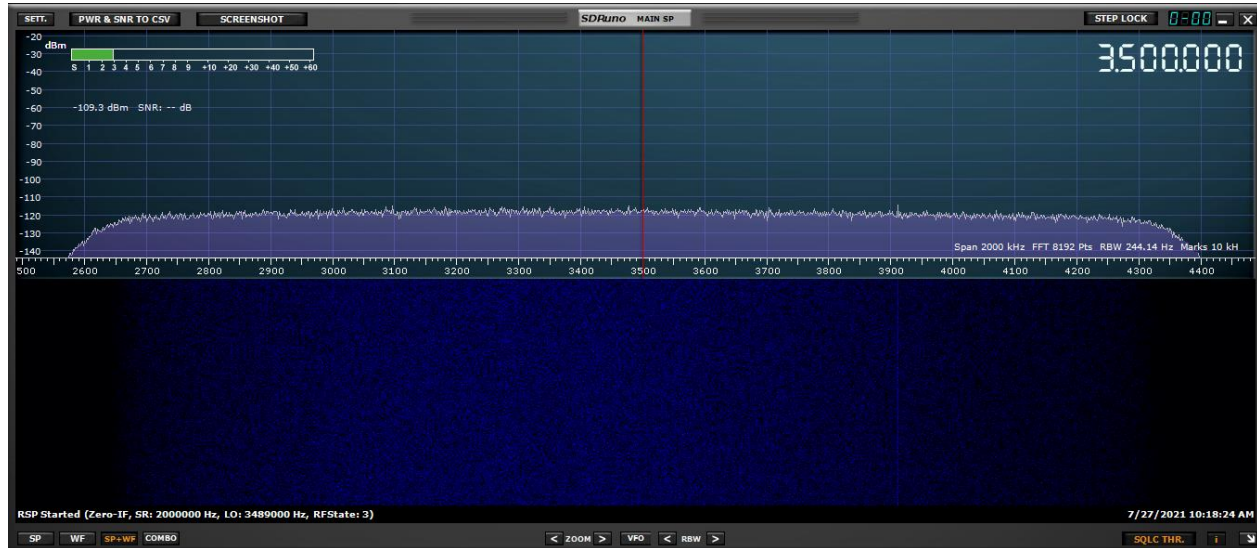

SETT: Displays the “MAIN SP” settings panel.

PWR & SNR to CSV: Enables the recording of power and SNR signal measurement. Adjustable via the MAIN SP SETT. button.

SCREENSHOT: Captures a full screen screenshot in JPG format.

STEP LOCK: Step locks the current VRX’s VFO.

0-00: 00 denotes what VRX is in use, the leading 0 specifies what SDRuno instance is in use.

STATUS BAR: Displays specific SDRuno status messages.

SP: Displays only the spectral display.

WF: Displays only the waterfall display.

SP+WF: Displays the spectral and waterfall display with divider.

COMBO: Displays the spectral and waterfall display combined without separation.

< ZOOM: Zooms out of the spectral and waterfall tuned frequency.

> ZOOM: Zooms into the spectral and waterfall tuned frequency.

VFO: Centres the tuned frequency when zoomed into the spectral and waterfall display.

< RBW: Decreases the resolution bandwidth and FFT size shown on the spectral and waterfall display.

> RBW: Increases the resolution bandwidth and FFT size shown on spectral and waterfall display.

SQLC THR.- Displays a squelch horizontal visual marker on the SP1 display. Uses the dBm value calculated in the audio bandwidth

i: Toggles the display of Span, FFT, RBW and Marks in the waterfall display.

->: Right clicking selects pre-set resolutions that the MAIN SP can be displayed.

☞: Allows the filter bandwidth zone to be moved up and down the visible spectrum by holding down the left mouse button while moving the mouse left and right. Note: 1 Hz resolution in this mode.

⊕: Move the mouse to where you want the VFO to be and then click the left mouse button to select the frequency.

2.3.1 Main SP Settings

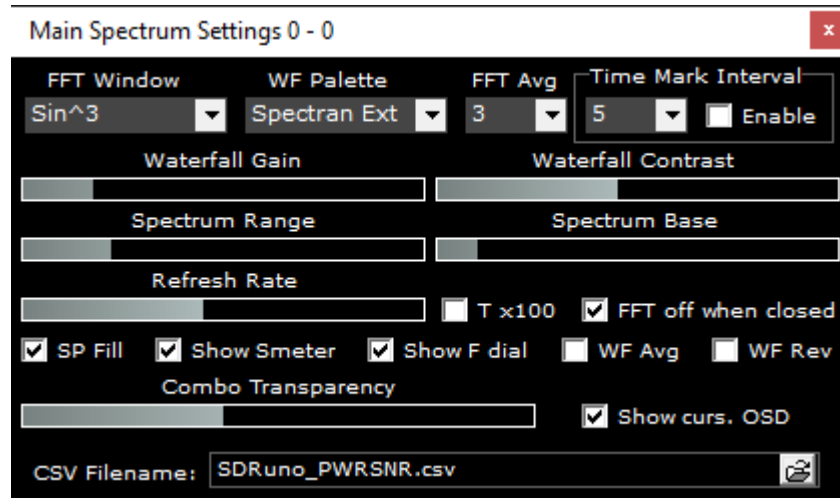

FFT Window: Selects the windowing algorithm that is applied to the FFT display.

WF Palette: Selects a pre-set color palette that is applied to the spectral and waterfall display.

FFT Avg: Averages the FFT display over the specified number of sweeps.

Time Marks: X number of seconds until the next time marker appears.

Waterfall Gain: & Contrast: Increases or decreases the color intensity of the spectral and waterfall display.

Spectrum Range: Increases or decreases the spectrum range.

Spectrum Base: Increases or decreases the spectrum base.

Refresh Rate: Increases or decreases the speed of the spectral and waterfall display.

Tx100: Multiplies the FFT interval by 100.

FFT off when closed: Stops FFT processing when the AUX SP window is closed.

SP Fill: Fills the region under the spectral trace.

Show S-meter: Enables or disables displaying the S-Meter.

Show F dial: Enables or disables displaying the VFO and LO frequency.

WF Avg: Enables the waterfall average.

WF Rev: Reverses the direction of the waterfall display.

FFT Avg: Averages the FFT display over the specified number of sweeps. - Adjusts the transparency (COMBO must be selected).

Show curs. OSD: Shows the frequency at the mouse cursors current position within the spectral display.

CSV Filename: Sets the power and SNR measurement file name and directory.

Marks Int: X number of seconds until the next time marker appears.

T Marks: Displays the current time a marker in the waterfall.

Waterfall Gain: & Contrast: Increases or decreases the color intensity of the spectral and waterfall display.

2.4 Scanner



Scanner Config: Open the scanner configuration panel.

Add Lockout: provides a 1 click lockout function when scanning.

0: Specifies what SDRuno instance is in use.

Play: Starts the scanner.

Pause: Pauses the scanner.

Advance: Resumes scanning when stopped on a signal

Stop: Stops the scanner.

Range: Selects frequency range scanning.

Mem: Selects memory bank scanning.

2.5 EX Control



(Clicking the EXW button in the RX CONTROL panel displays the EX CONTROL panel)

0-00: 00 denotes what VRX is in use, the leading 0 specifies what SDRuno instance is in use.

BW: (mouse wheel adjustment): Set the bandwidth of notch filters 1-4. Use the mouse wheel to adjust the value.

FREQ: (mouse wheel adjustment): Set the centre frequency of the notch filters 1-4 in Hz. Use the mouse wheel to adjust the value

N1-N4: corresponds to each notch filter NCH1 - NCH4 (notch filters 1-4).

AM SOFT FILTER: (button): Clicking the "SOFT" button to activate the AM mode soft filter.

FC: (mouse wheel adjustment): Specify the cut-off frequency of AM soft filter. Use the mouse wheel to adjust this value.

AGC: (slider): Adjust the AGC threshold by sliding to the left and right.

NB: (slider): Adjust the threshold of the noise blanker by sliding to the left and right.

NR: (slider): Adjust the threshold of noise reduction by sliding to the left and right.

CWPK: (slider): Adjust the threshold of CWPK (the function that automatically tunes to the peak of CW) by sliding to the left and right.

FM DEEM: (button): Clicking the "DEEM" button to activate the de-emphasis function. Select 50 uS or 75 uS: (50 uS for non-US regions and 75 uS for US regions).

AFC: (button): Clicking the "AFC" button enables the automatic frequency tuning function.

MONO: (button): Clicking the "MONO" button switches to mono reception mode.

FMS-NR: (button): Clicking the "FMS-NR" button to activate Noise Reduction algorithm for FM stereo.

FMS-NR: (slider): Adjust the FMS-NR threshold by sliding to the left and right.

PDBPF: (button): Click to enable Pure Data Band Pass Filter. This filters PL tones from FM demodulated transmissions.

LC & HC: (mouse wheel adjustment): You can adjust the low cut-off "LC" frequency value and the high cut-off "HC" frequency value. Use the mouse wheel to adjust the value.

2.6 Scheduler & Recorder

A comprehensive new scheduler and recorder is featured in release 1.41. This replaces the recorder panel in releases 1.40.2 and earlier. The scheduler operates using one or more timed 'events'. An event can be either to play the I/Q stream from an attached RSP, record the I/Q stream or operate the frequency scanner. Events can load profiles and start one or more plugins. Events can also be single instances which start and finish at pre-defined points in time or can be recurring events that can be run hourly, daily, weekly or monthly. Recurring events can be limited to run until a specified date, run a pre-determined number of times or operate with no specified end.

The recorder can be used manually, or recording can be started from within an event using the scheduler. Playback of an I/Q recording is a manual process and operates as before with an I/Q WAV file being selected as an input source from the Main Panel Options. The scheduler and recorder panel can be opened by clicking on the scheduler button on the Main Panel or by selecting the 'Include Scheduler' layout option from the Auto Layouts section of the Main Panel Options. Please note that the 'Include Scheduler' layout option will only work for display resolutions of 1920x1080 or higher ([see section 3.9](#)).

When an event is active, it will be highlighted in green. If two events conflicts in time, only the first event on the list will run and the conflicting event(s) will be highlighted in red. The event editor will not warn the user of future conflicting events and so it is important that the user checks the listed events for possible conflicts before any of the events are due to commence.

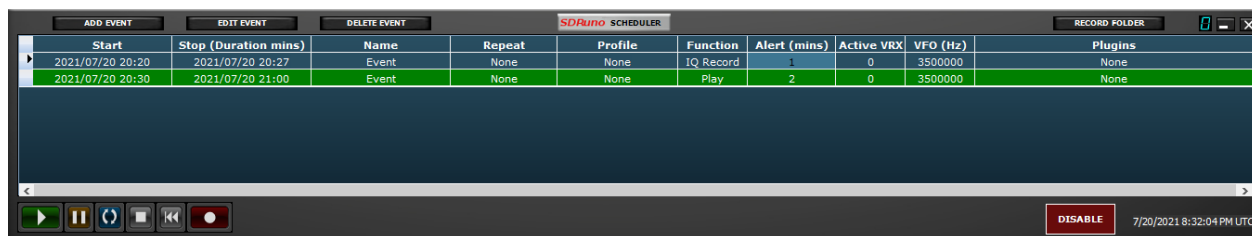

(Clicking the SCHEDULER button in the MAIN panel displays the SCHEDULER panel)

ADD EVENT: Opens the scheduler event configuration editor panel.

EDIT EVENT: Edits a selected event.

DELETE EVENT: Deletes a selected event.

RECORD FOLDER: Specifies the default user folder used to save recorded IQ files.

Start: Displays the assigned start time and date of event.

Stop (Duration mins): Displays the assigned stop time and date of event. The duration is only displayed for recurring events

Name: Displays the scheduled event name given.

Repeat: Displays the scheduled event recurrence if applicable.

Profile: Displays the assigned profile associated with the scheduled event.

Function: Displays the event function assigned to the scheduled event.

Alert (mins): Displays a notice in the status bar (x) number of minutes before the start of a scheduled event. Also, for Windows 10 and above a Windows notification will also be triggered.

Active VRX: Displays the VRX number assigned to the scheduled event.

VFO (Hz): Displays the VFO assigned to the scheduled event. Note: if a profile is used, this VFO frequency overrides the VFO frequency stored in the profile.

Plugins: Displays the plugin(s) selected to be used in the scheduled event.

0: Displays the SDRuno instance in use.

Play: Manually plays back a loaded pre-recorded IQ stream.

Pause: Pauses playback of the pre-recorded IQ stream.

Loop: Loops the playback of the pre-recorded IQ stream.

Stop: Stops the recording or the playback of the pre-recorded IQ stream.

Back: Plays the pre-recorded IQ stream from the beginning of the recording.

Record: Starts the manual recording of an IQ stream.

DISABLE/ENABLE: Enables or Disables operation of the scheduler. Scheduled events will not run unless Enable is selected

Date and Time: Displays the current system date and time.

2.6.1 Scheduler Event Editor

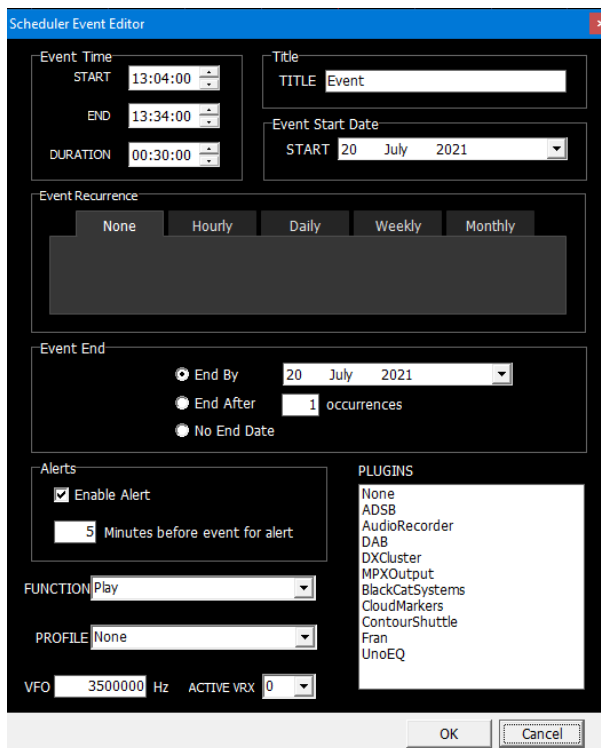

Event Time:

Start- Specifies the scheduled event start time.

End- Specifies the scheduled event end time.

Duration- Duration between the event start and end time. The duration span can be adjusted without the need to readjust the end time.

Title: User defined text string for the scheduled event name

Event Start Date:

Start- Date specified to start the scheduled event.

Event Recurrence:

None- Scheduled single event.

Hourly- Scheduled event with hourly recurrence.

Daily- Scheduled event with daily recurrence.

Weekly- Scheduled event with weekly recurrence.

Monthly- Scheduled event with monthly recurrence.

Event End (Recurring events only):

End By- Date to end the recurring scheduled event.

End After- End recurring scheduled event after (x) number of occurrences.

No End Date- The recurring event scheduled is ongoing and will not end by a set date or number of occurrences.

Alerts:

Enable Alert- Displays a visual alert in the status bar and a Windows notification before a scheduled event

Minutes before event for alert- Number of minutes before an event specified displays the notification (Windows Notification in Windows 10 and later only)

Function:

Play- Starts the SDRuno stream.

IQ Record- Records an IQ WAV file.

Scan- Scans a range of frequencies or a memory bank. A range scan event will use the current scanner settings. Use a profile to configure specific scanner settings for the event.

Profile: Assigns a profile to the event if required.

VFO: The frequency assigned to a scheduled event.

Active VRX: Allows a VRX to be selected if more than one VRX is in use.

Plugins: Allows a plugin to be assigned to a scheduled event. Multiple plugins can be selected by holding down the Ctrl key and clicking on the desired plugins list of available plugins. (Note: at time of publication, not all plugins will have the autostart feature added, please check with the author of the plugin if you are not seeing it start with an event)

OK: Completes the editing of a scheduled event.

Cancel: Cancels editing of a scheduled entry.

2.6.2 Scheduler Example 1

Recording the Medium Wave broadcast band at the top of the hour for later playback.

1- Launch SDRuno, select the appropriate input from the Main panel. Launch the scheduler panel by clicking the scheduler button from the MAIN panel. Navigate to the RX CONTROL panel, select MW from the band framing buttons. This will frame the entire Medium Wave band. Note the system time and click Add Event button from the Scheduler panel.

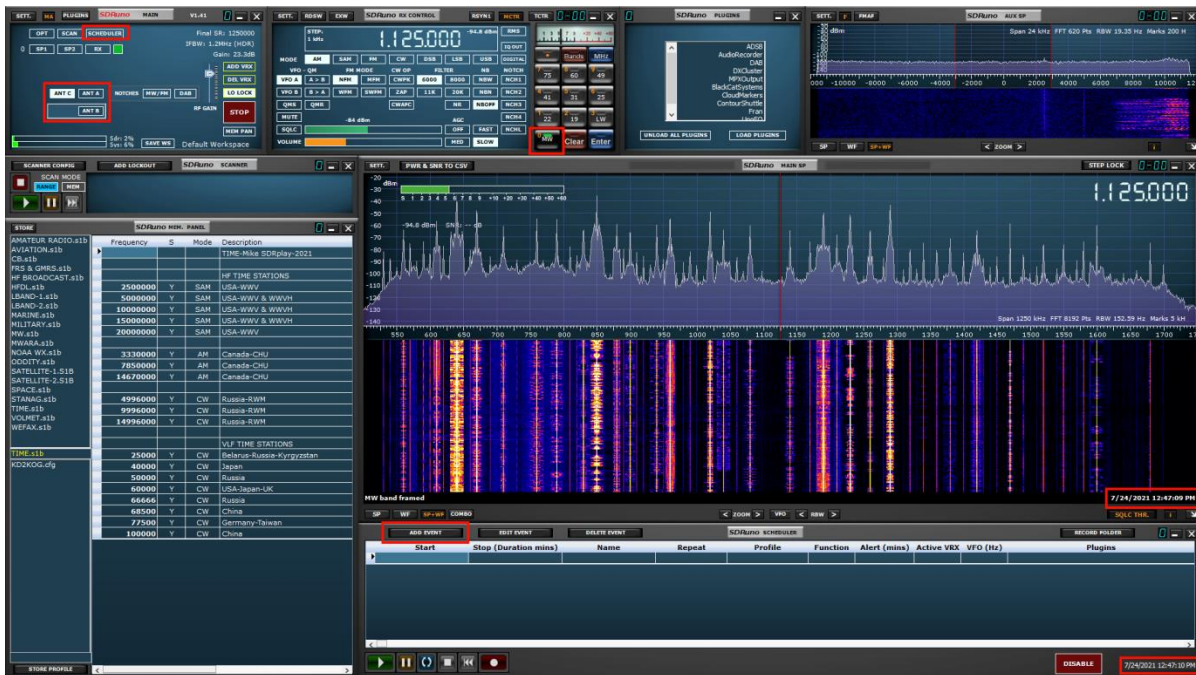

2- Adding an event to the Scheduler Event Editor will instruct SDRuno to perform an IQ recording at a specific time for a specific length of time. The recording will capture the entire Medium Wave band starting at 12:59. The recording duration is 11 minutes.

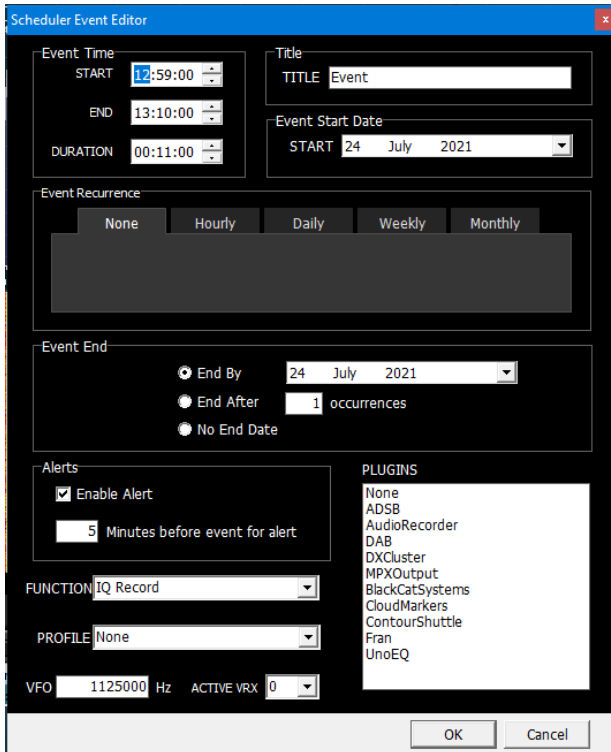
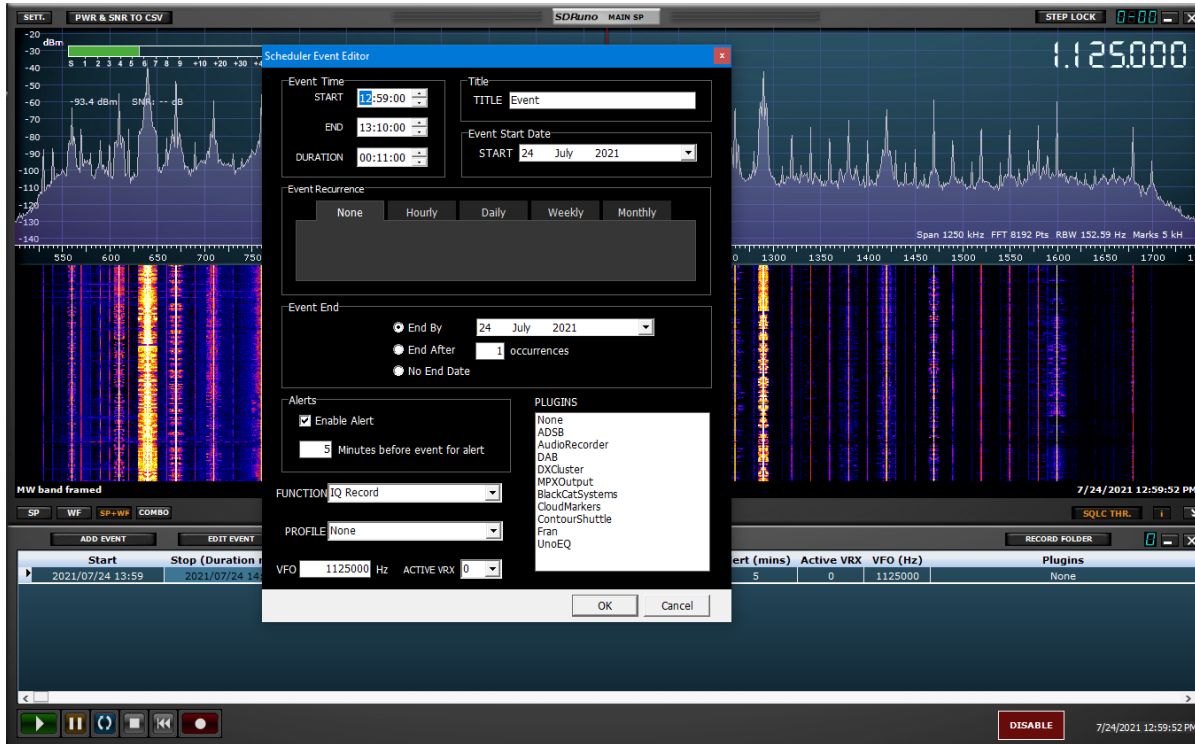

In the event time box, set the START and END time. You can also adjust the End time by editing the Duration.

Give the event a memorable name by editing the Title.

Select the Date for the IQ recording.

Select *the frequency which this IQ recording will take place. It can be hourly, daily, weekly, or monthly.*

Select when to end the IQ recording. On a date, after x number of occurrences or **with** no end date.

Choose if you would like to be notified x number of minutes before the IQ recording takes place. (Windows Notification in Windows 10 and later only)

The Event editor has 3 major functions. Play, IQ Record and Scan. Select IQ Record. IQ files by default will reside in your "My Documents" folder.

A SDRuno profile can be assigned and loaded when the IQ recording starts. We will not use one.

Since the band was framed, and 1125000 Hz is the center of the medium wave band. We will not edit the VFO frequency.

We will not assign a VRX or a SDRuno plugin.

Click OK to add the event.

3- When an event starts, it will highlight green. This is to notify you of what event is being processed. All event information is shown in the Scheduler panel. If any changes need to be made. You can edit the event by clicking the Edit event button. If an edit needs to be made near the Start of an event. Disable the Scheduler by clicking the Disable button and edit the event. This will stop the Scheduler from running whilst the user is in the process of editing it. Click the Enable button to enable the scheduler.

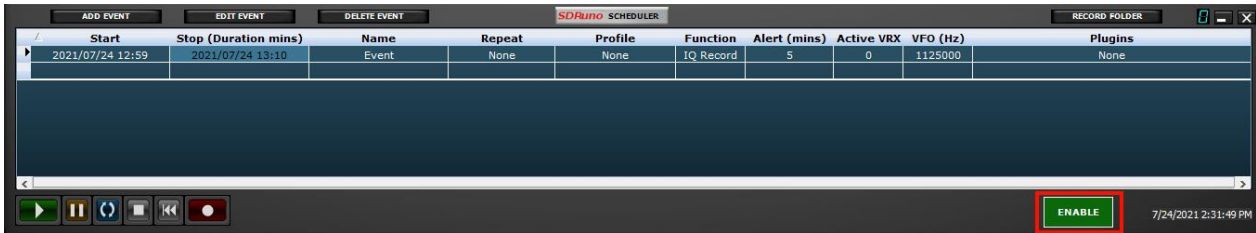
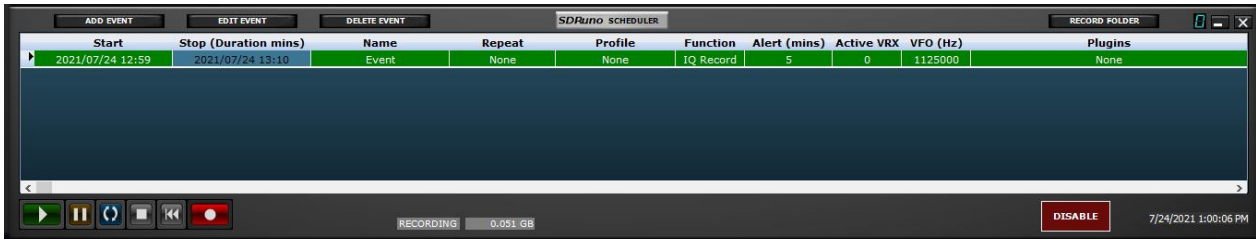

4- To play back the recording. Select the WAV file. Clicking the green Play button will start the playback of the recording.

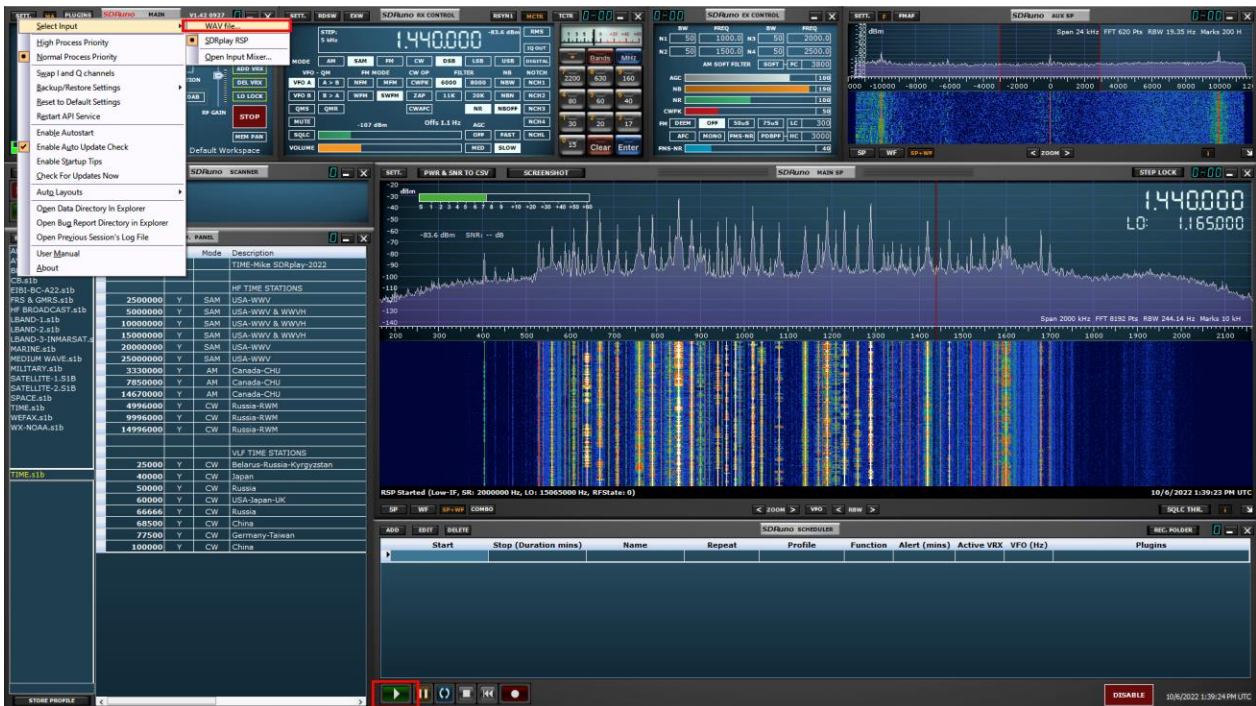

5- You can now point and click on signals hunting for station ID's. The Scheduler controls all playback functions. pause, loop, stop and restart. The scheduler also displays the IQ file name and time stamp information. You can scrub throughout the recording using the blue scrub bar. The current system time is shown on the bottom right of the Scheduler.

The screenshot displays the SDRplay software interface. At the top, there's a 'PWR & SNR TO CSV' window showing a power spectrum with a peak at -66.5 dBm and SNR of 18.2 dB. Below it is a waterfall plot showing signal activity over time. The main window is titled 'SDRplay MAIN SP' and shows a frequency spectrum from 550 to 1700 kHz. The bottom section is the 'SDRplay SCHEDULER' window, which contains a table of recording events and playback controls.

Start	Stop (Duration mins)	Name	Repeat	Profile	Function	Alert (mins)	Active VRX	VFO (Hz)	Plugins
2021/07/24 12:59	2021/07/24 13:10	Event	None	None	IQ Record	5	0	1125000	None

At the bottom of the scheduler window, there are playback controls (play, pause, stop, previous, next) and a scrub bar. The scrub bar shows the file name 'SDRplay_20210724_165955Z_1125kHz.wav' and the current time 'Jul 24, 2021 - 17:00:03Z'. An 'ENABLE' button is visible on the right, and the system time '7/24/2021 2:49:48 PM' is shown in the bottom right corner.

2.6.3 Scheduler Example 2

Tune a FM broadcast station and record the transmission as a MP3 file at a specific time.

- 1- Launch SDRuno, select the appropriate input from the Main panel. Launch the scheduler panel by clicking the scheduler button from the MAIN panel. Note the system time and click Add Event button from the Scheduler panel.

The screenshot shows the SDRplay SDRuno interface. The main window displays a frequency of 106.300000 MHz. The Scheduler panel is open, showing a list of events and an 'ADD EVENT' button highlighted in red. The Scheduler panel includes fields for Event Time, Title, Event Start Date, Duration, Event Recurrence, Event End, Alerts, and Function. The 'ADD EVENT' button is highlighted in red.

- 2- Add the event to the Scheduler Event Editor. This will instruct SDRuno to start a recording on a specified date and time for a specific period. The audio recording will be in MP3 format and this event will use a stored profile to apply an adjusted RF GAIN setting (Main panel).

The screenshot shows the SDRplay SDRuno interface with the Scheduler Event Editor dialog box open. The dialog box is titled 'Scheduler Event Editor' and contains the following fields: Event Time (08:20:00), Title (Event), Event Start Date (30 July 2021), Duration (00:10:00), Event Recurrence (None), Event End (End By 30 July 2021), Alerts (Enable Alert), and Function (Play). The 'ADD EVENT' button is highlighted in red.

In the event time box, set the START and END time. You can also adjust the End time by editing the Duration.

Give the event a memorable name by editing the Title.

Select the Date for the MP3 recording.

Select the event recurrence. This MP3 recording can take place. Hourly, Daily, Weekly, or Monthly.

Select how to end the scheduled event. On a date, after x number of occurrences or with no end date.

Choose if you would like to be notified x number of minutes before the MP3 recording takes place. (Windows Notification in Windows 10 and later only)

A SDRuno profile is assigned and loads when the event starts.

Enter the FM broadcast station frequency (88.1 FM) in Hz (88100000)

Click and select the AudioRecorder plugin. This will assign the AudioRecorder plugin to the scheduled event. Audio files recorded with the AudioRecorder plugin are stored in the "My Documents" folder by default.

Click OK to add the event.

3- When an event starts, it will highlight green. This is to notify you of what event is being processed. All event information is shown in the Scheduler panel. If any changes need to be made. You can edit the event by clicking the Edit event button. If an edit needs to be made near the Start of an event. Disable the Scheduler by clicking the Disable button and edit the event. This will stop the Scheduler from running whilst the user is in the process of editing it. Click the Enable button to enable the scheduler.

Start	Stop (Duration mins)	Name	Repeat	Profile	Function	Alert (mins)	Active VRX	VFO (Hz)	Plugins
2021/07/30 08:20	2021/07/30 08:30	Event	None	WAYFM.cfg	Play	5	0	88100000	AudioRecorder

Start	Stop (Duration mins)	Name	Repeat	Profile	Function	Alert (mins)	Active VRX	VFO (Hz)	Plugins
2021/07/30 08:20	2021/07/30 08:30	Event	None	WAYFM.cfg	Play	5	0	88100000	AudioRecorder

4- After the event takes place, SDRuno places the MP3 recording into your My Documents folder for later playback.

The screenshot shows the SDRplay software interface with a Windows File Explorer window open over the 'Documents' folder. The File Explorer displays a list of files and folders:

Name	Date modified	Type	Size
Audio	6/9/2021 3:42 PM	File folder	
CommunityPlugins	7/29/2021 10:23 AM	File folder	
Custom Office templates	11/22/2020 2:07 PM	File folder	
ELAD	11/19/2020 5:19 PM	File folder	
HSDR	7/23/2021 3:17 PM	File folder	
SDRuno	6/21/2021 6:08 PM	File folder	
Wondershare	11/19/2020 6:22 PM	File folder	
DXToolBox-FM-Logbook.qlogite	4/16/2021 9:25 AM	SQLite File	8 KB
DXToolBox-Logbook.qlogite	4/25/2021 7:22 PM	SQLite File	8 KB
DXToolBox-Mediumwave-Logbook.qlogite	11/20/2020 4:02 PM	SQLite File	8 KB
SDRuno_20210730_082002_88100000HZ	7/30/2021 8:30 AM	MP3 Audio File (V...	11,824 KB
SWBC-Reminders.bin	7/25/2021 5:48 PM	BIN File	1 KB

The SDRplay interface in the background shows a frequency display at 88.100000 MHz, a waterfall plot, and a 'Scheduled Event Stopped' notification. The event log shows a recording event that occurred on 2021/07/30 from 08:20 to 08:30.

2.7 Memory Panel

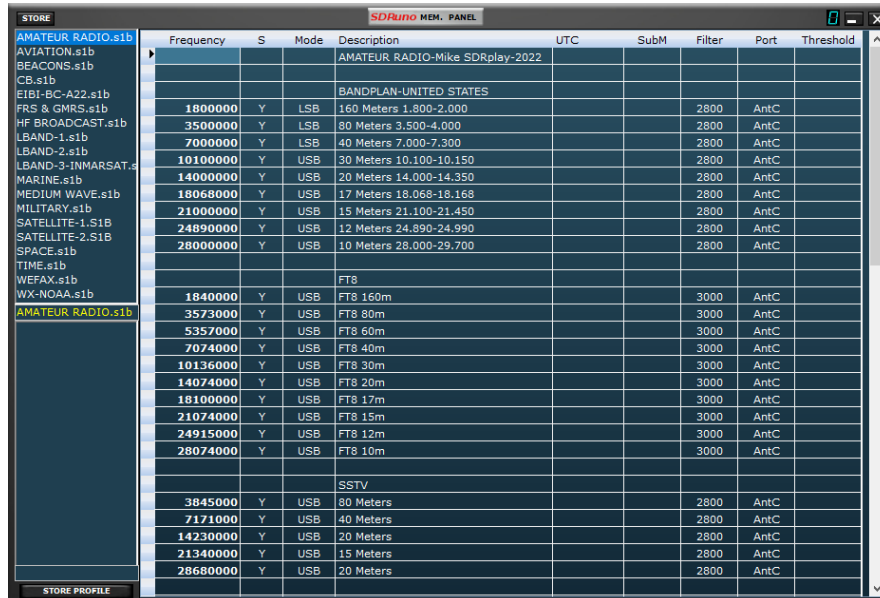

(Clicking the MEM PAN button in the MAIN panel displays the memory panel)

Store: Places the tuned frequency into the current bank selected.

0: Specifies what SDRuno instance is in use.

Store Profile: Places SDRuno settings into a user created Profile file that can be recalled.

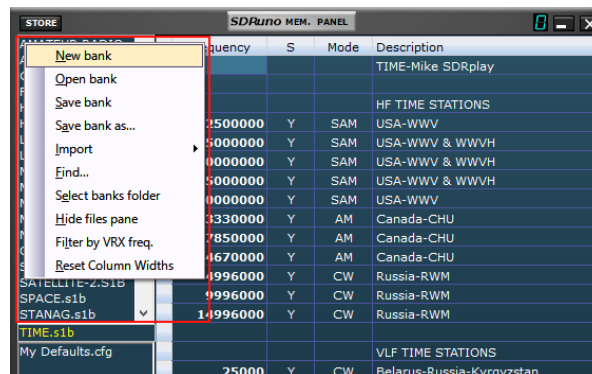

Double clicking on an s1b file in the list on the left will open the selected bank and make it active.

Additional "bank" options are available by right clicking the mouse inside upper left of the MEMORY PANEL.



Double clicking on a cfg file in the list on the left will open the selected profile configuration and make it active.

Additional "profiles" options are available by right clicking the mouse inside the lower left of MEMORY PANEL.

2.8 Aux SP (SP2)

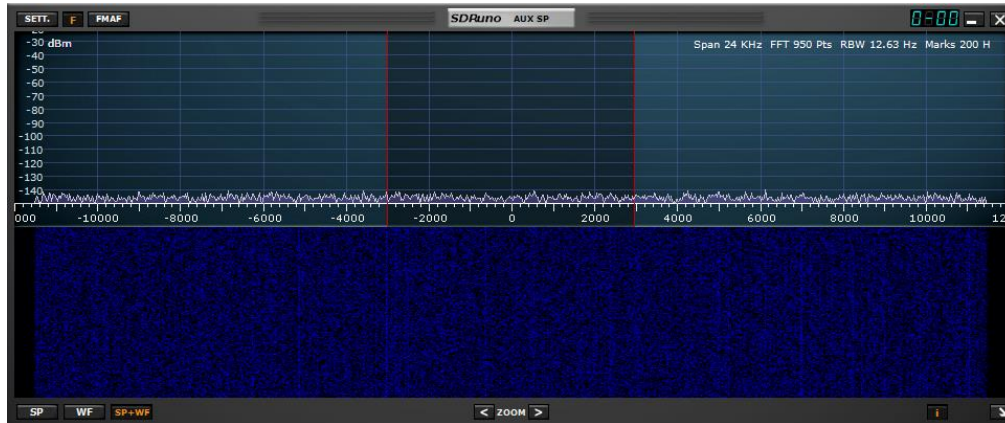

SETT: Displays the “AUX SP” settings panel.

F: Toggles between filtered and nonfiltered display of the visual passband.

FMAF: Enables FM DirectBand display.

0-00: 00 denotes what VRX is in use, the leading 0 specifies what SDRuno instance is in use.

SP: Shows only the spectral display.

WF: Shows only the waterfall display.

SP+WF: Shows the spectral and waterfall display with divider.

< ZOOM: Zooms out of the spectral display.

> ZOOM: Zooms into the spectral display.

I: Toggles the display of Span, FFT, RBW and Marks in the spectral display.

->: Resizes the “AUX SP” panel.

2.8.1 Aux SP Settings

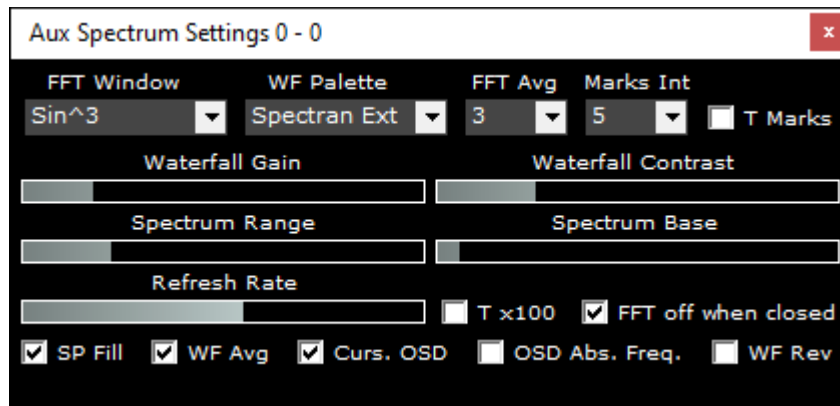

FFT Window: FFT Window: Selects the windowing algorithm that is applied to the FFT display.

WF Palette: Selects a pre-set color palette that is applied to the spectral and waterfall display.

FFT Avg: Stabilizes the spectral display.

Marks Int: X number of seconds until the next time marker appears.

T Marks: Displays the current time a marker in the waterfall.

Waterfall Gain & Contrast: Increases or decreases the color intensity of the spectral and waterfall display.

Spectrum Range: Increases or decreases the spectrum range.

Spectrum Base: Increases or decreases the spectrum base.

Refresh Rate: Increases or decreases the speed of the spectral and waterfall display.

Tx100: Multiplies the FFT interval by 100.

FFT off when closed: Stops FFT processing when the AUX SP window is closed.

SP Fill: Fills the region under the spectral trace.

WF Avg: Enables the waterfall average.

Curs. OSD: Displays the frequency at the mouse cursors position within the spectral display.

WF Rev: Reverses the direction of the waterfall display.

2.9 RDS Info

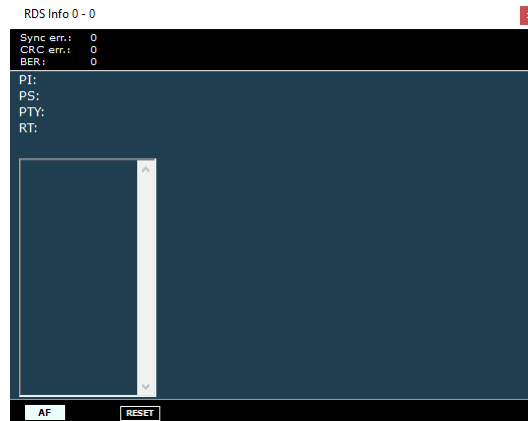

(Clicking the RDSW button in the RX CONTROL panel displays the RDS info panel)

- Sync err:** Displays synchronization errors
- CRC err:** Displays cyclic redundancy check errors
- BER:** Displays block error rate.
- PI:** Displays program identification code.
- PS:** Displays program service name.
- PTY:** Displays program type code
- RT:** Displays radio text.
- AF:** Displays alternative frequencies if available from the transmitting station.
- RESET:** Reinitializes the RDS decoder.

2.10 Plugins

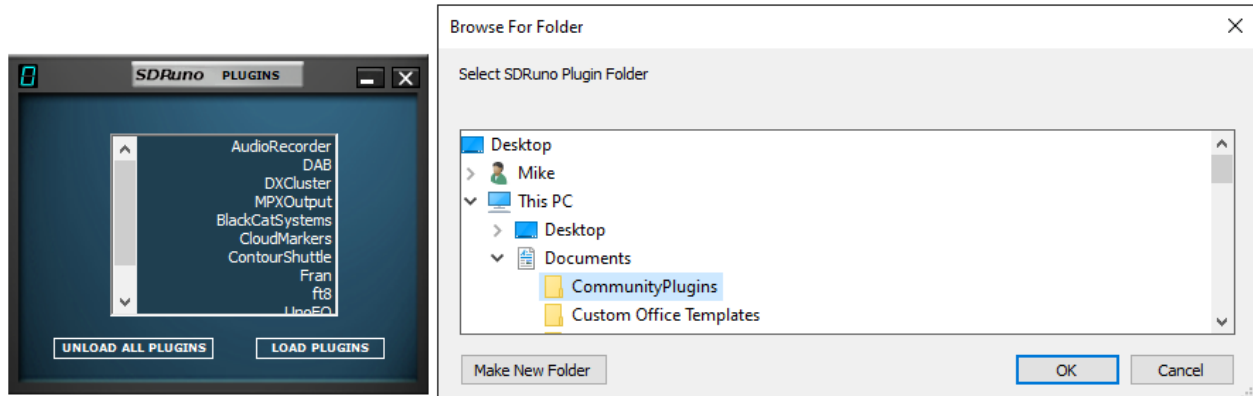

Unload All Plugins: Closes all loaded plugins.

Load Plugins: Loads and launches the select plugin

Right click panel: Sets the folder file path of installed community plugins.

Introduced in Version 1.4, the SDRuno Plugin System allows for the development of external applications that interact with SDRuno. Thus, allowing development of new features to be carried out by the community outside of the SDRuno development cycle.

The Plugin Control panel displays both the plugins that are delivered with SDRuno and plugins that are found in a user defined location.

3rd party plugins can be downloaded and put into a plugins folder of your choice. Then, right click on the Plugin Control panel background and a folder select window will appear. The folder you have put plugins into can be selected and the plugin list will update and display them.

Any number of plugins can be selected and loaded at any time using the load plugin button. Each plugin can then be unloaded by closing its window, or the unload all plugins buttons can be pressed to remove all plugins from memory.

When the workspace is saved in SDRuno, all open plugins can store their current location so that they become part of the workspace layout.

For those that are interested in developing plugins, please see our GitHub repository with information, documentation, and sample code here: <https://github.com/SDRplay/plugins>

3 - Getting Started

3.1 Application instance

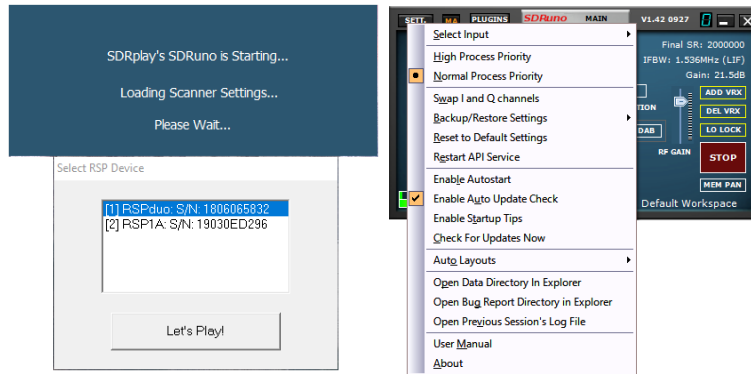

Starting from V1.4, SDRUno no longer requires a RSP present to start. Each instance of SDRUno can either be started using a RSP or a pre-recorded IQ WAV file. If there is more than one available RSP present, a popup window will appear allowing you to select which RSP to use. If the SDRUno instance has been started with a RSP, an IQ WAV file can be selected as an input from the Main Panel OPT menu. If no available RSPs are present, a window will appear asking if you want to start SDRUno with an IQ WAV file.

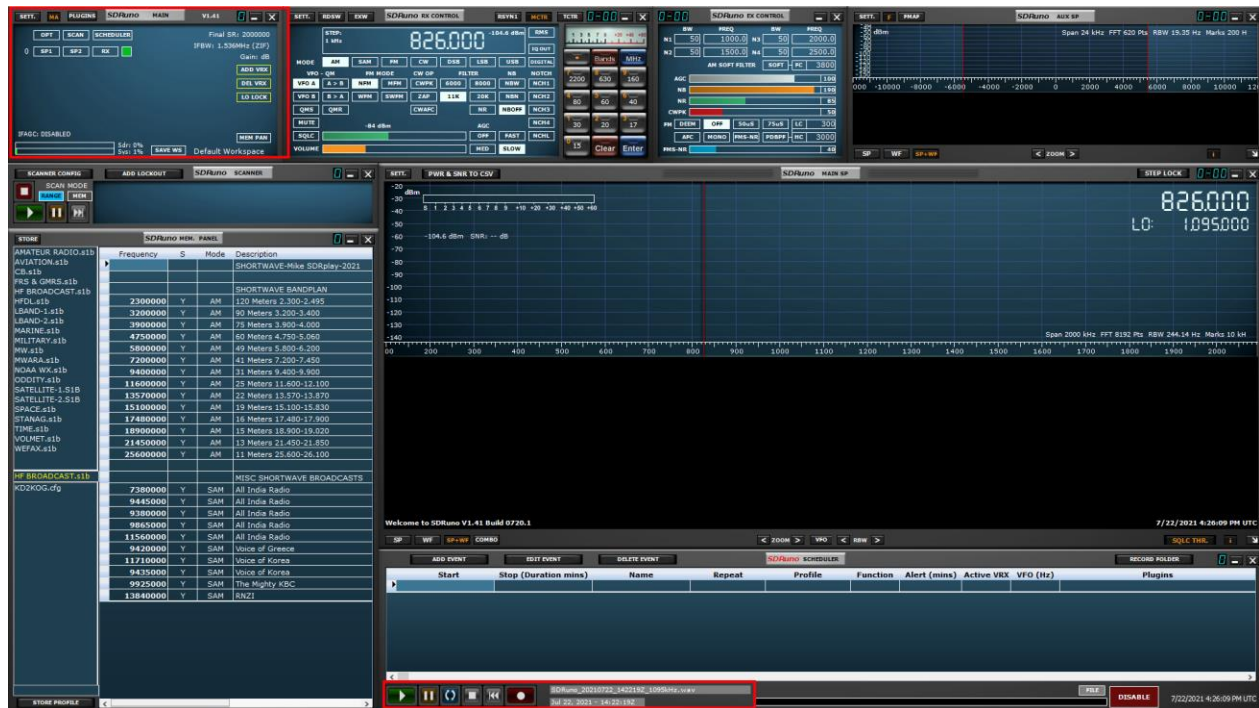
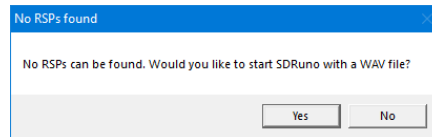

3.2 Resetting SDRuno

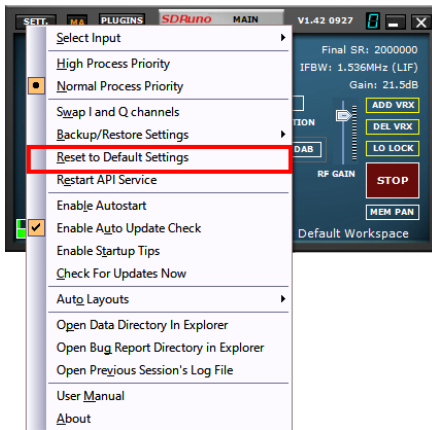

SDRuno Ini File Reset Warning

Are you sure you want to reset SDRuno to it's original defaults?

Clicking yes will close ALL SDRuno instances and remove SDRuno's ini file
When you next start SDRuno it will be back at factory defaults

This process cannot be undone



Resetting SDRuno back to a default state is done within the Main panel, click the OPT button and selecting Reset to Default Settings. Resetting SDRuno can't be undone. All settings will be cleared and all instances of SDRuno will be shut down. All workspaces will also be deleted by doing this. SDRuno will then be restarted.

If SDRuno is unable to be launched, you can perform a reset by navigating to the SDRuno installation folder and double clicking the batch file named "Removelni"

SDRuno stores its settings in %appdata%\SDRplay\SDRuno.ini after SDRuno has been closed. Please note that RSP settings (except RSP1) are stored by serial number.

3.21 Backup and restore SDRuno

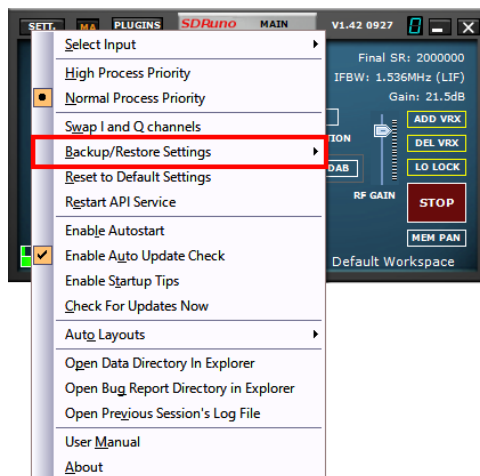

Backing up and restoring SDRuno settings is done within the Main panel, click the OPT button and select Backup current settings. SDRuno stores its backup file in a drive and folder location you specify.

3.3 SDRplay RSP devices

RSP's all have specific features. These features can be selected via the MAIN panel. Further controls for specific models are available by clicking on the SETT. button within the MAIN panel.

Starting from V1.4, SDRuno no longer requires a RSP present to start. Each instance of SDRuno can either be started using a RSP or a pre-recorded IQ WAV file. If there is more than one available RSP present, a popup window will appear allowing you to select which RSP to use. If the SDRuno instance has been started with a RSP, an IQ WAV file can be selected as an input from the Main Panel OPT menu. If no available RSPs are present, a window will appear asking if you want to start SDRuno with an IQ WAV file.

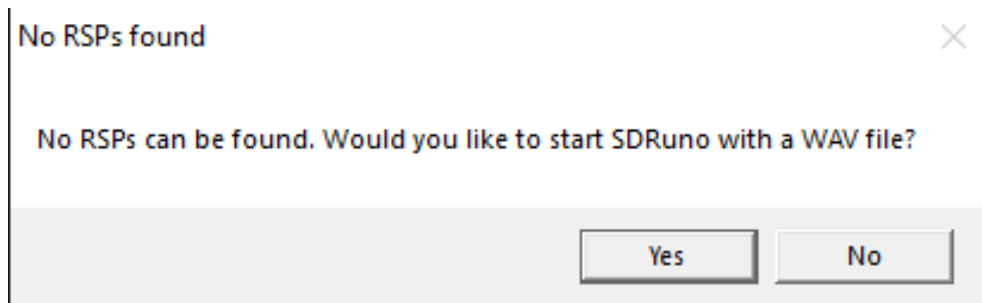

No Device or IQ file playback

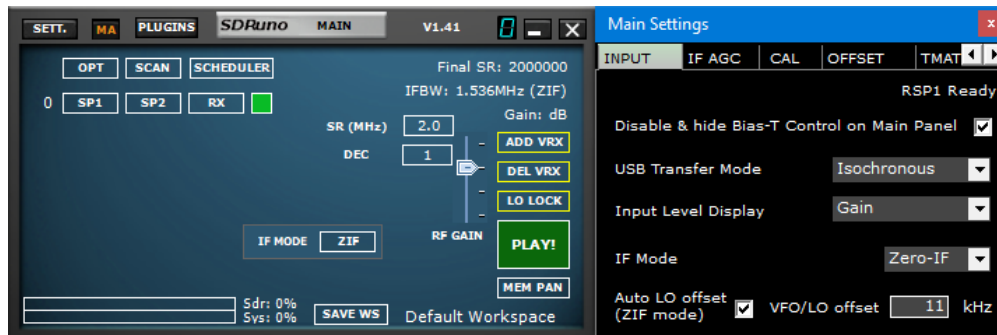

RSP1

<https://www.sdrplay.com/wp-content/uploads/2017/01/161129RSP1DatasheetV3.pdf>

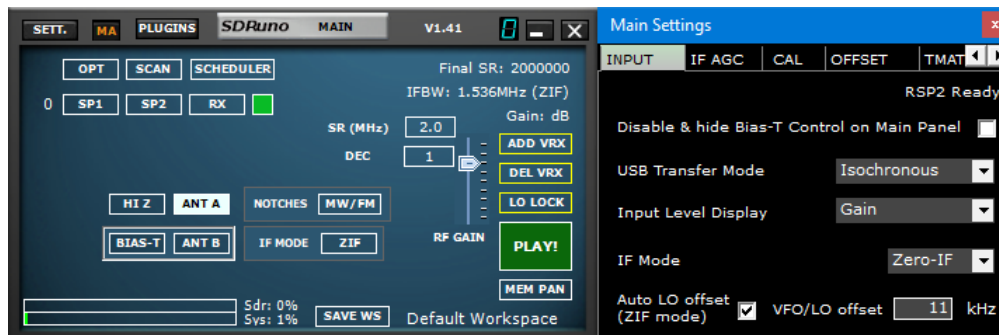

RSP2/RSP2pro

<https://www.sdrplay.com/docs/RSP2andRSP2proDatasheetv2.2.pdf>

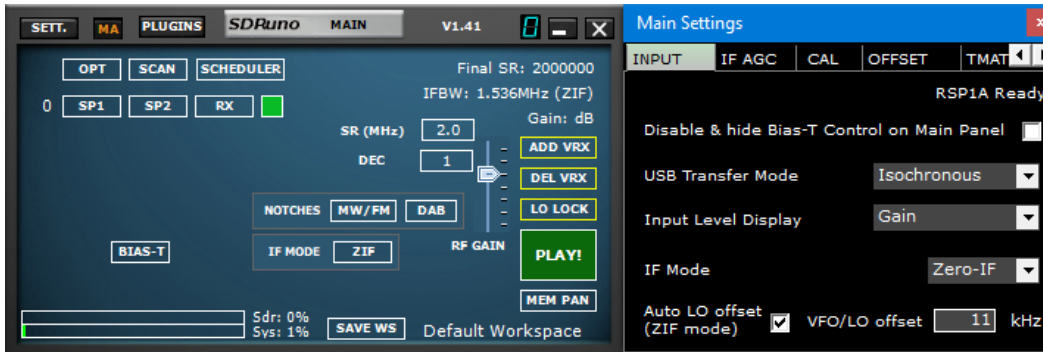

RSP1A

<https://www.sdrplay.com/docs/RSP1Adatasheetv1.9.pdf>

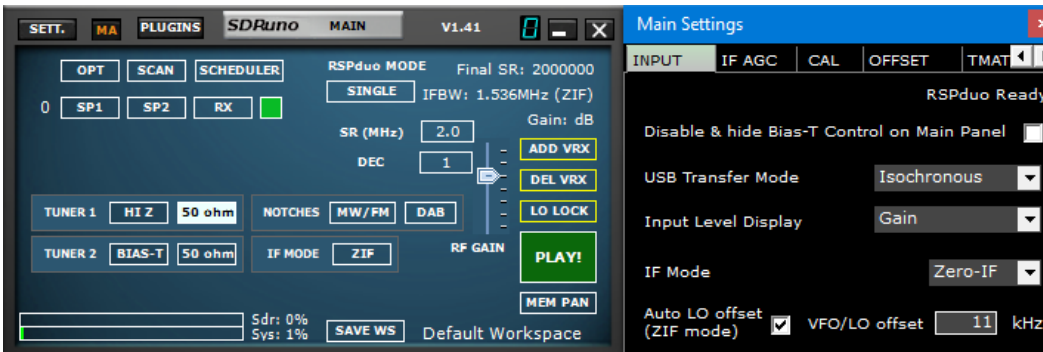

RSPduo-Single tuner mode

<https://www.sdrplay.com/wp-content/uploads/2018/05/RSPduoDatasheetV0.6.pdf>

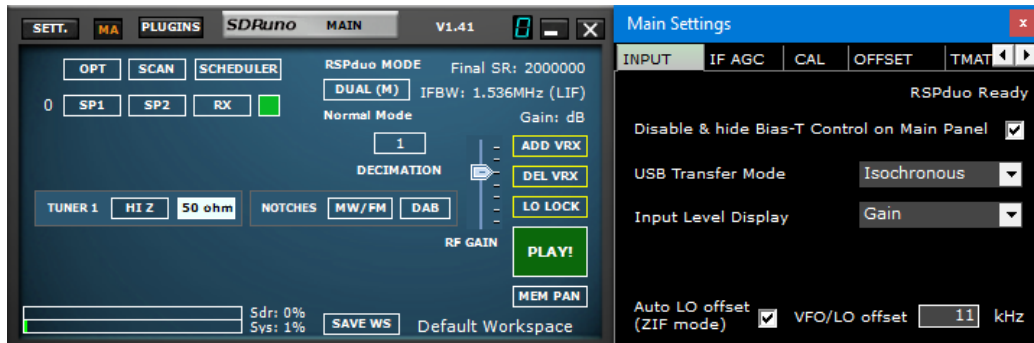

RSPduo- Master/Slave mode

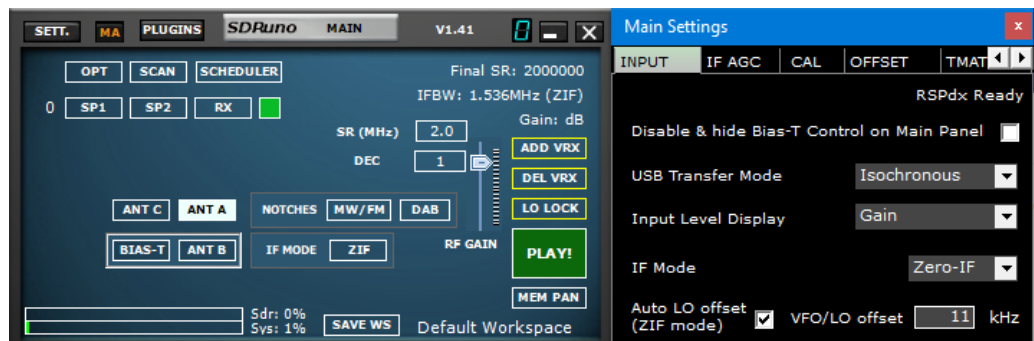

RSPdx

<https://www.sdrplay.com/resources/RSPdxDatasheet.pdf>

3.4 Starting the RSP stream



Starting the RSP in SDRuno is by clicking the green PLAY button shown in the MAIN panel. The PLAY button will become red and relabelled to STOP. Clicking the STOP button will stop the SDRuno stream. Clicking on the top right X closes the SDRuno application. SDRuno can also autostart the stream by selecting “Enabled Autostart” within the MAIN panel OPT settings.

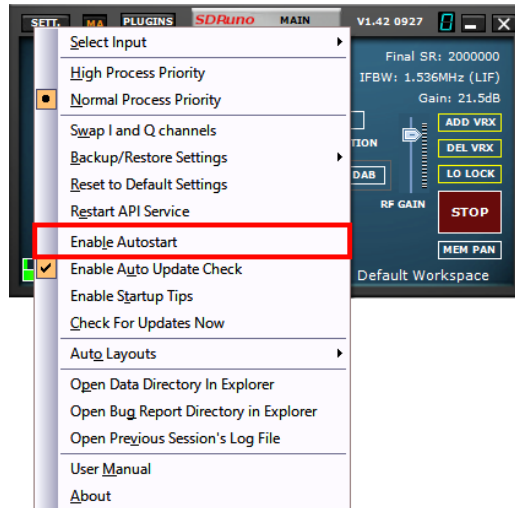
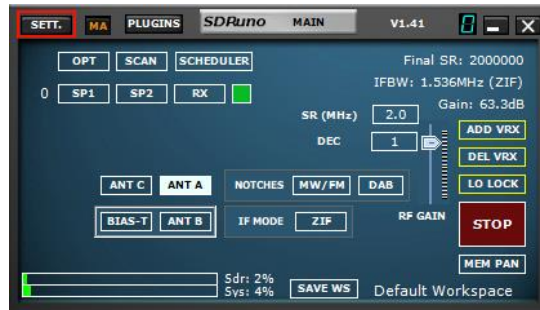

3.41 Startup Tips

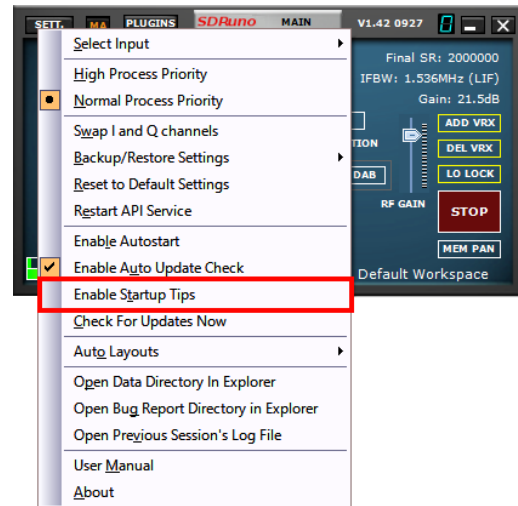
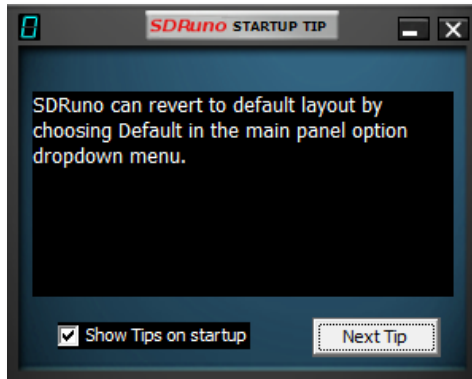

SDRuno will display a window on launch showing a random operation tip.... The Next Tip button will show another random tip.

3.5 Selecting an output device



Each VRX can have its WME output device. More VRX can share the same WME device. Output device can be selected in RX Control->Settings->Out Tab. If no device is selected (default) the VRX will use the system default (sound mapper). SDRuno must have an output device. For more details on Virtual Receivers (VRXs), please refer to section [4.12](#)

3.6 Setting the RX frequency



You have multiple choices for inputting a frequency value:

- Clicking on one of the band buttons (under the S-meter in the RX Control panel).
- Moving the cursor to a specific digit in the frequency display (inside the RX Control panel or inside SP1 if the dial is enabled) and turning the mouse wheel.
- Using the current tuning step turning the mouse wheel (when the cursor is outside any control and one of the VRX panel is selected).
- Entering the frequency directly with the mouse and/or the keyboard.
- Clicking on the Main Spectrum panel (spectrum or waterfall); the actual selected frequency is the nearest multiple of the current tuning step.
- Using the Memory Banks features.
- Using a dedicated hardware controller (Tmate – Tmate 2).
- Using CAT control and/or Omnirig.



SDRuno displays the frequency Hz.

3.7 Step Size

If you wish to change the step size. Select the mode. Right click on the frequency readout. Select the new step size.



3.8 Entering frequency directly

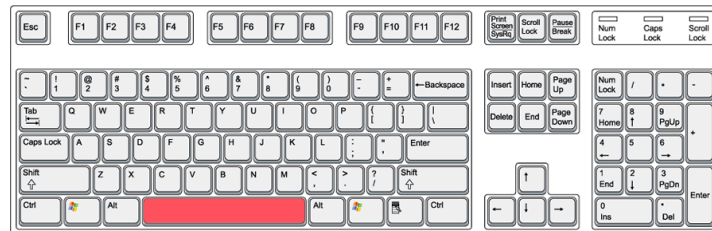

If you wish to use the keyboard, one of the VRX panels must be selected. In order to enter a frequency directly with the keyboard and/or mouse:

- Press the SPACE bar or click on the RX Control frequency dial; this will start the input sequence. The Rx Control Frequency Display will display 0 and the white frame around the frequency display will turn to yellow. In order to abort the input sequence, press the ESC key or click on the Clear button in the RX Control panel.
- Note: SDRuno will stay in frequency entry mode UNTIL you either press ENTER on the keyboard or press the blue ENTER button on the RX control panel keypad.

- The frequency is entered in kHz using the numeric keys and/or clicking on the band buttons. If you wish to enter Hertz values, use the decimal separator of your system. For example, if you wish to enter 1455202 Hz type in 1455.202 (or 1455,202 depending on the system). Note: you can use whatever decimal separator you wish; the program will replace it automatically (if needed) with the correct one.
- To enter the frequency in MHz either use MHz button shown in the RX Control keypad or type m on the keyboard. For example, if you wish to enter 146.520 MHz type in 146.52 & hit the MHz button or type 146.52m

3.9 Workspace

Once you have started SDRuno you will have predetermined workspace based on the monitor resolution in use. You can still customize and build a custom workspace.

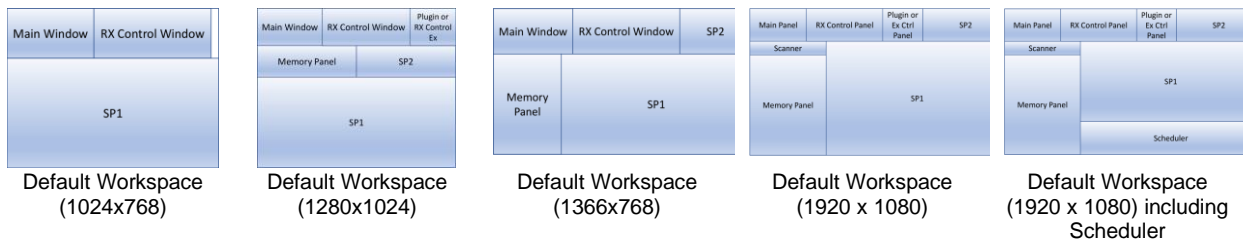

In SDRuno a workspace contains size and position information for all open panels. A workspace can be renamed. The first time you run SDRuno, you will have the workspace #0 recalled; its default name is “Default Workspace”. The last saved workspace in each instance is stored at program exit and recalled at the next start-up. Once you are satisfied with your panel layout you can save the workspace.

3.9.1 Auto Layout

SDRuno allows you to revert workspace 0 back to the predetermined workspace at any time by choosing Default in the main panel option dropdown menu.

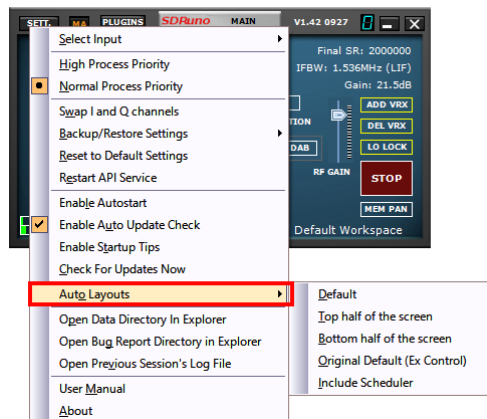

Default- Creates the predetermined workspace based on the monitor resolution. (3.9)

Top half of the screen- For the RSPduo. (21)

Bottom half of the screen- For the RSPduo. (21)

Original Default (Ex Control)- Replaces the Plugin panel with the Ex Control panel. (2.5)

Include Scheduler- Adds the Scheduler panel. The scheduler auto layout feature only works in 1920x1080 or above. (2.6)

3.10 Managing Workspaces

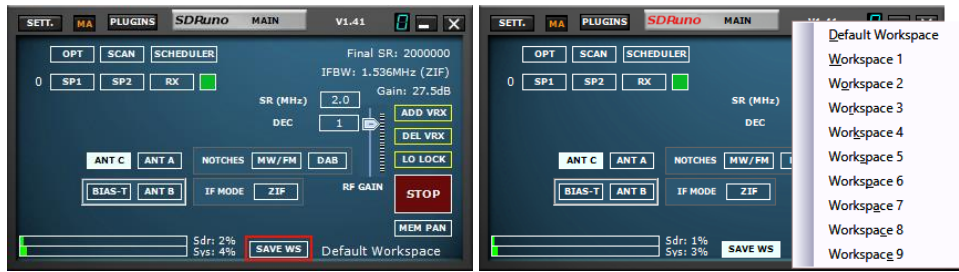

In order to manage workspaces, there are the following options:

Save the current panels set to a workplace memory position.

1. Click on the SAVE WS icon, the workspace selection dialog will open
2. Click on the Workspace location you want to use.
3. A workspace saved message will appear in the status bar.
4. The workspace you just saved will have the same name as the workspace that was active when you set up the new panel placements. To rename your new workspace right click on the workspace label name and type in the new name. Press return.

Recall a workspace (making it the current workspace): Left-Click on the workspace name to popup the workspace list and Left-Click on the workspace you want to recall.

Rename the current workspace: Right-Click on the workspace name label in the Main panel, enter the new name then press Enter to confirm or ESC to abort.

3.11 Minimize/Restore All option



As the SDRUno GUI is made of many independent panels, an option to minimize or restore all the panels of an instance with a single action can be very handy sometime. The “minimize-restore all” option is controlled by the small “MA” button located in the upper left of the Main panel. When enabled, minimizing or restoring the RX Control or the RX EX Control panel will result in minimizing or restoring all the opened panels in the relative SDRUno instance.

3.12 Temporary LO Lock



Changing the hardware LO has the effect of changing the tuning frequency of all the active VRX. This happens when you change the tuning frequency of VRX #0 (the master RX). If you wish to change the frequency of VRX #0 without changing the hardware LO you can use the LO LOCK button in the Main panel. But if you need only a temporary lock simply press the SHIFT key while tuning.

3.13 Frequency calibration

In SDRUno the hardware frequency calibration can be done manually in Main panel ->Settings->Cal or automatically in the VRX Control panel ->Settings->Cal. For manual calibration, you can input a value in Parts Per Million; that value will be positive if the hardware oscillator is lower than its nominal frequency or negative otherwise. You can perform the calculation of the compensation value at any frequency, but best accuracy is achieved using the upper tuning range of the hardware. You need a reference signal whose frequency is known and accurate (for example in HF could be WWV on 15000 kHz). For automatic calibration, follow the instructions within the VRX control panel ->Settings->Cal tab.



3.14 Keyboard shortcuts

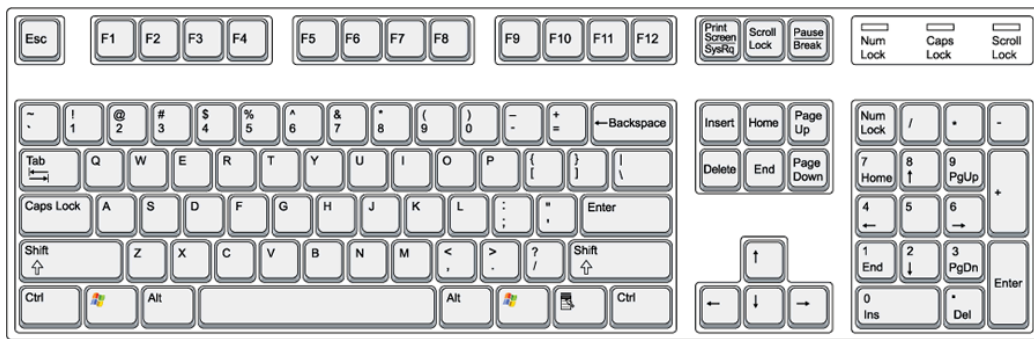

RX control panel

↑	Up frequency step.
↓	Down frequency step.
CTRL-S	Save frequency to memory bank.
Space Bar	Start frequency edit.
ESC	Aborts direct frequency input.
A	AM.
C	CW.
D	DSB.
E	DIGITAL.
F	FM.
L	LSB.
M	Medium band FM.
N	Narrow band FM.
O	Stereo wideband FM.
S	SAM.
T	Toggle RX<->TX.
U	USB.
W	Wideband FM.

SP1 panel

V	Centre on VFO.
+	Zoom in.
-	Zoom out.
CTRL-L	Step Lock.

Main panel

*	Start/Stop Recording.
B	Open/Close Memory panel.
K	Toggle LO LOCK.
P	Start/Stop stream.
CTRL-W	Save Workspace.

Memory panel

F2	Edit current cell.
CTRL-F	Show/hide files pane.
CTRL-S	Save frequency to memory bank.
B	Open Memory panel.
Ins	Inserts a new row.
Del	Deletes the current row.

4 - SDRuno Functions

SP1 or “Main spectrum” panel: Shows the spectrum of the signals from the input device. This panel is resizable, and its settings are stored and recalled together with the relative VRX. Also, it can be closed or minimized to the task bar.

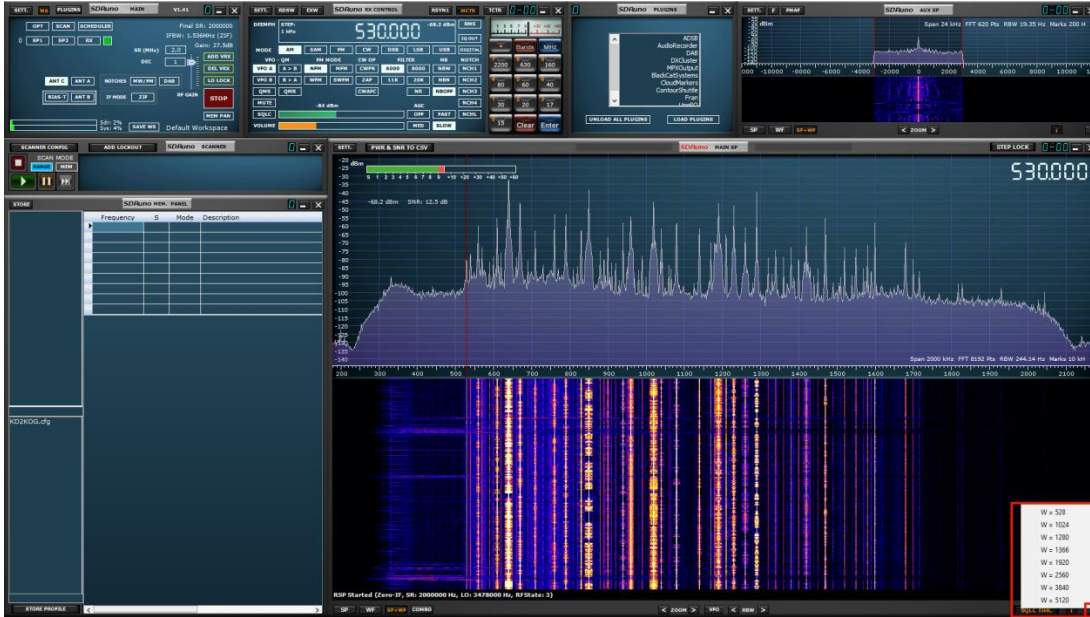

The Main SP can be freely resized, or a pre-set resolution width can be selected by right clicking the arrow on the lower right corner of the Main SP.

4.1 Status Bar

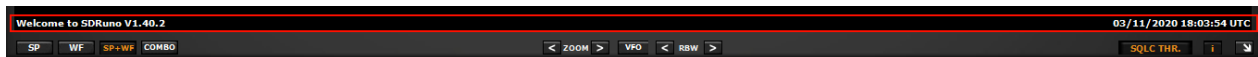

The status bar will display SDRuno messages and the current system time (local or UTC). To display the time in UTC, navigate to the MAIN panel, click the SETT. icon and click the MISC tab, place a check in SHOW UTC TIME.

4.2 Zoom



< Zoom > Zooming in and out on the MAIN SP is done by clicking on the < > icons. SDRuno has 8 zoom steps and will auto centre on the current signal selected by the VFO.

4.3 VFO

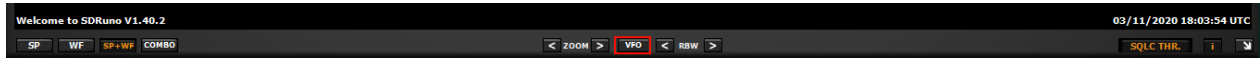

When zooming in and out of the MAIN SP you can have the VFO centre within the MAIN SP by pressing the VFO button.

4.4 Resolution bandwidth

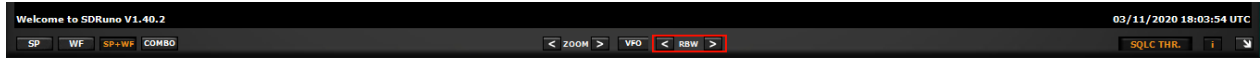

RBW is the detail of the spectrum display. Very fine frequency resolution can be achieved with smaller values. There is no optimum value. The choice of resolution bandwidth depends on modulation and how much detail you wish to observe. Lowering the RBW will tend to increase CPU load.

Squelch Threshold.

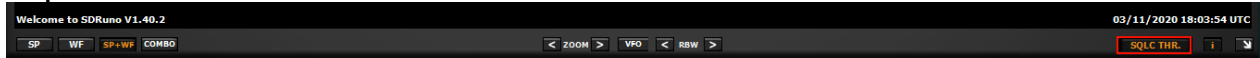

SQLC THR. Displays a yellow horizontal line across the MAIN SP spectral display. The squelch button in the RX CONTROL must be enabled. Squelch adjustment is via the SQLC slider in the RX CONTROL panel.

Note: Squelch threshold is displayed as dBm, the power is the power measured by the power meter shown in the MAIN SP (using the demodulation bandwidth of the AUX SP)

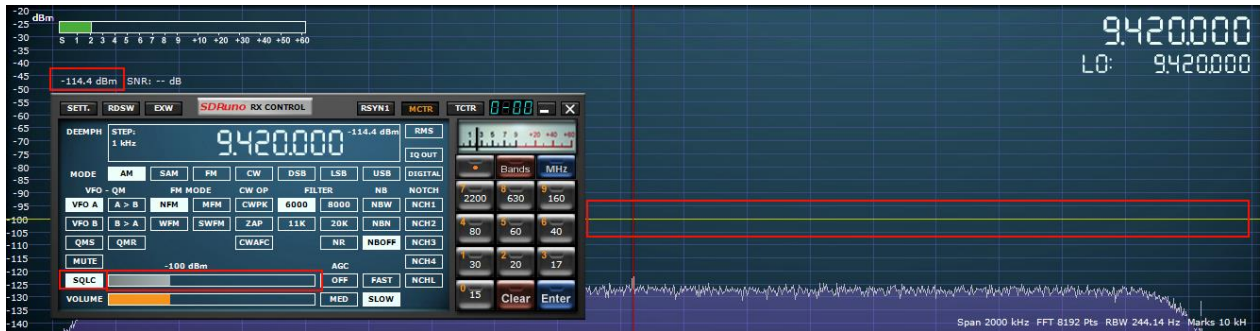

4.5 The spectrum "quick browser"

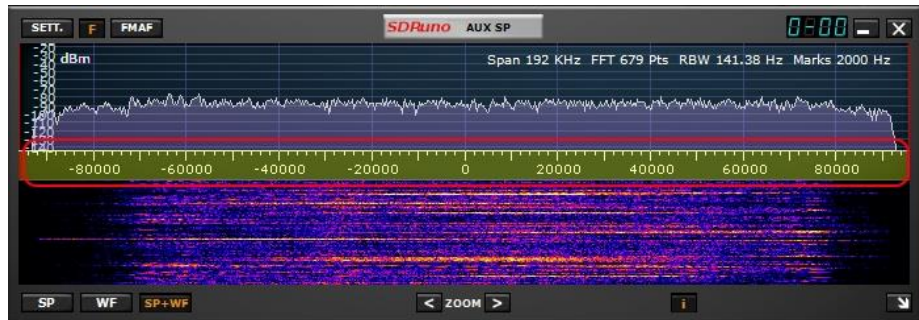

Sometimes in the spectrum panel you need a high zoom factor and at the same time you need also to move quickly to another part of the spectrum. Therefore, SDRplay has the "quick browser" function:

- Place the cursor inside the frequency scale.
- Press the SHIFT key, a yellow overlay will appear on a portion of the scale: here the size and position of this overlay indicates the currently shown portion of the spectrum relative to the total (the whole frequency scale).
- Click and drag the above overlay until the panel shows the spectrum portion you wish.

4.6 SP2 filter adjustments

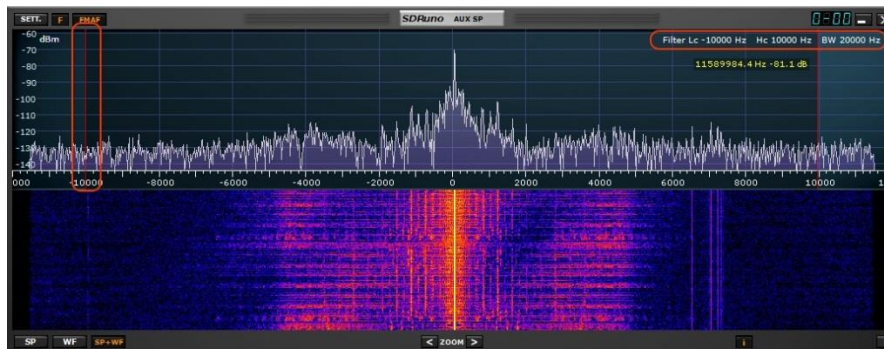

You can manually adjust the SP2 filter bandwidth by left clicking with your mouse on either of the red bars and dragging them to the desired frequency.

4.6.1 Asymmetrical adjustment

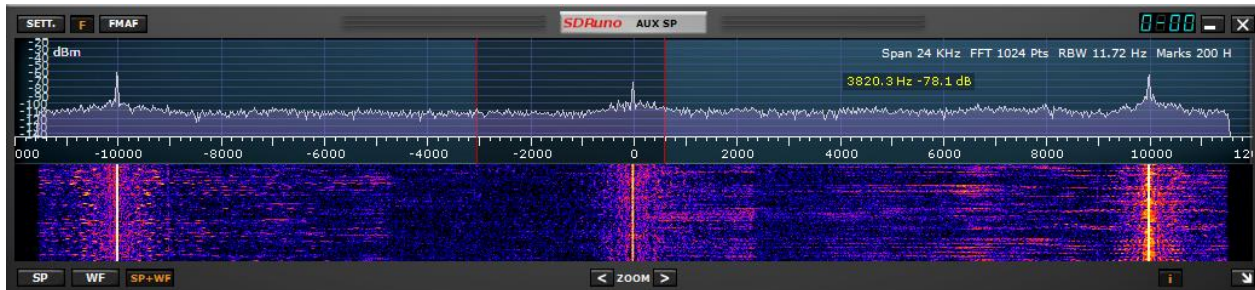

Besides the usual dragging of the selectivity filter edges (the red cursors) in the SP2 panel there are other useful features available. Usually in AM, SAM (DSB) and FM mode, dragging one edge has the effect of controlling simultaneously the other in order to create a symmetric filter (around 0). In SDRuno the selectivity filter high and low frequency parameters can be different. If you wish to set up an asymmetrical filter drag one edge while pressing the CTRL key.

4.6.2 Pass band Tuning

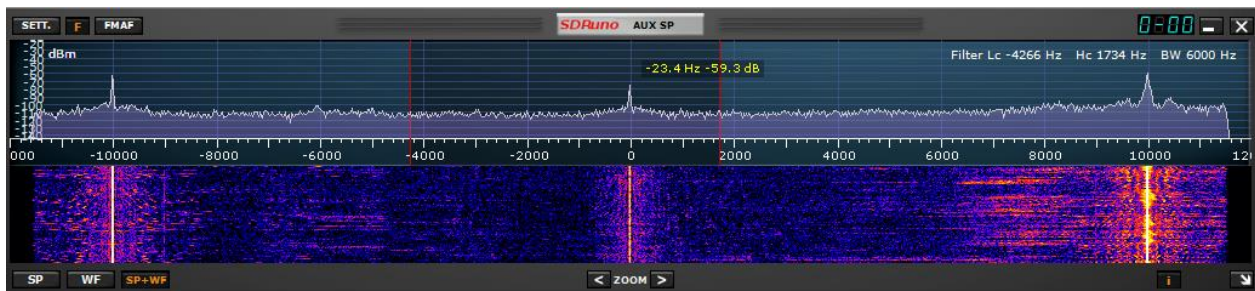

Place your mouse cursor in between the red filter markers. Right click and hold your mouse. The AUX SP will now display the filters Low Cut and Hi Cut frequencies. While still holding down the right mouse button, move your mouse left or right within the AUX SP, this will have the effect of moving both the filter edges (pass band tuning).

4.6.3 CW pitch (CW shift)

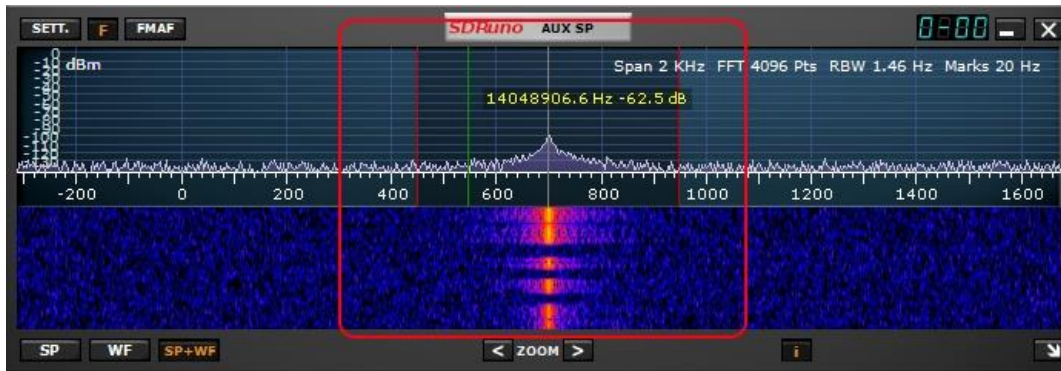

In CW receiving mode a VRX uses a frequency offset in order to obtain a CW tone. This offset can be set as follows:

- Make sure you have pressed Play! (so that the spectrum panel updates).
- Select CW receiving mode.
- Place the cursor in the spectrum part of the Aux Spectrum panel (SP2); a green vertical line will be shown at cursor position.
- Choose your new CW pitch moving the above line to the corresponding mark on the frequency scale; a positive value will set a “lower than carrier” offset (USB-CW) while a negative value will set a “higher than carrier” offset (LSB-CW).
- Assign the new offset by Left-Click while pressing the CTRL key.

4.7 Adjusting the proportion of spectrum and waterfall displays

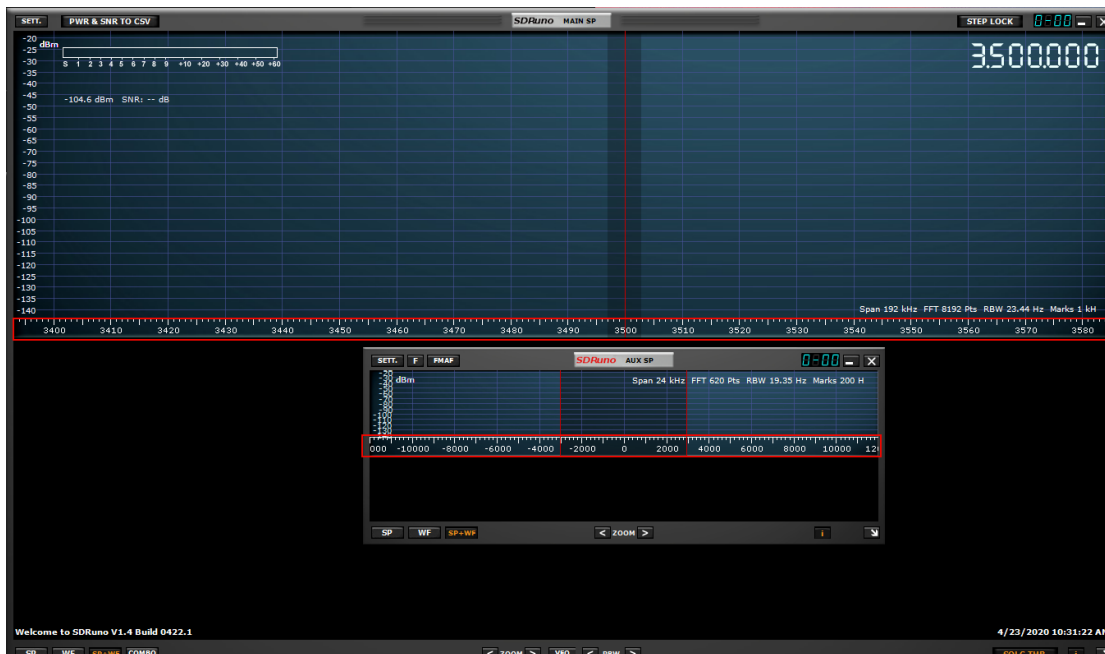

Inside SP1 and SP2 panel, for the SP+WF display mode you can alter the proportion of the SP vs. WF by right-clicking the frequency scale and dragging it vertically to the desired position.

4.8 Aux Spectrum Display.

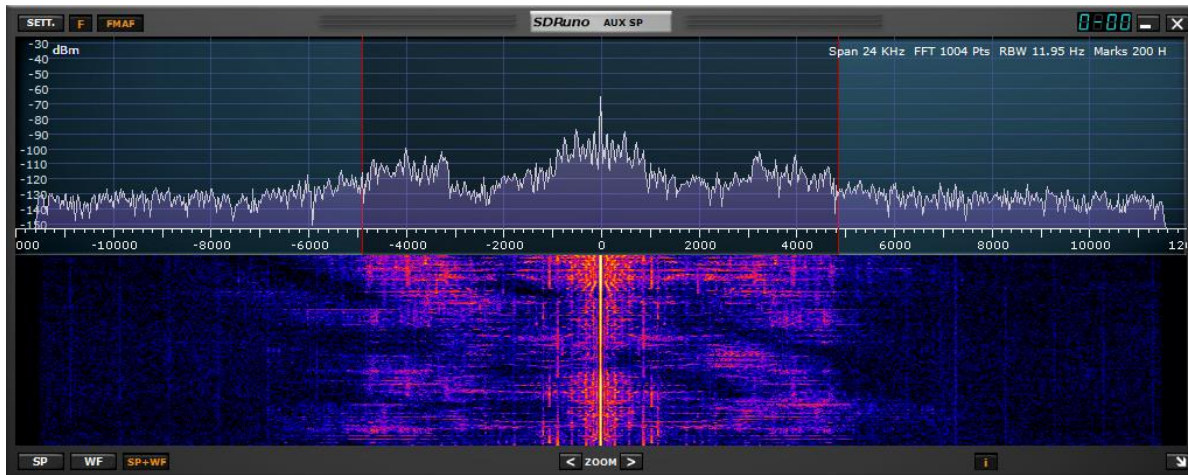

SP2 or “Aux spectrum” panel shows the spectrum in the down-converted bandwidth. Here you can modify the selectivity filter, place notches etc. This panel is resizable, and its settings are stored and recalled together with the relative VRX. Also, it can be closed or minimized to the task bar.

4.9 VRX

A VRX (Virtual Receiver) is a receiver implemented in software. Each VRX takes the signal from the defined sample rate processes it and will output the demodulated signal to an output device available of your choice.



SDRUno can create and run multiple VRX inside the same application instance. When you run an instance of SDRUno, a single VRX is always created: it is the “master” VRX or VRX #0. VRX #0 has some peculiarities:

- can't be disabled or deleted
- it is the only VRX that can change the LO of the RSP

4.9.1 Adding and removing a VRX.

SDRuno must be stopped to add or remove a VRX. SDRuno has a theoretical maximum of 16 VRXs. However, due to increases in the FFT size to support higher levels of zoom for each VRX, the practical limit is more likely to be 8 to 10. It will vary due to the available contiguous memory for a 32bit application.



ADD VRX – This allows you to add an additional VRX, this can only be added if the RSP is stopped. The additional VRX must be in the selected bandwidth you have selected (SR MHz).

DEL VRX – This allows you to delete the last VRX on the list. The VRX can only be deleted if the RSP is stopped

Each VRX includes three default panel: **SP1, SP2 and RX Control panels.**

5 - Scanning



SDRuno scanning has two modes. It can either scan a list of frequencies that already exist in the memory panel, or it can perform a 'blind scan' of a region of spectrum with a defined step size and either stop when it finds a signal and remain on signal for as long as the signal is present or remain on signal for a user defined period of time. It also can save frequencies found via the blind scan to the memory panel and allow you to manually skip forward, manually pause the scan or lockout a frequency using the lockout button. When frequencies are tuned to from the memory panel during a memory panel scan, the mode, sub-mode, and filter bandwidth fields are also used.

Note: SDRuno complies with US law and prevents the scanning of cellular frequencies

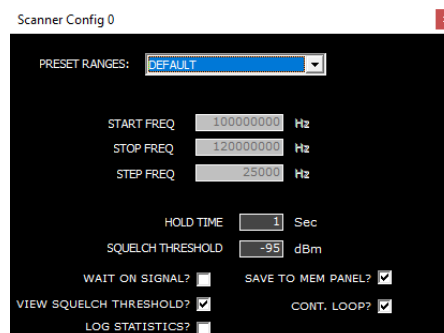



PRESET RANGES – Displays the assigned and custom ranges.

Selecting one of the eight custom preset ranges (1-8) allows editing of the following fields

Name – Editable custom preset text entry

START FREQ – Starting Frequency in Hz.

STOP FREQ – Ending Frequency in Hz,

STEP FREQ – Step size in Hz.

The “Save Preset” button also stores the currently selected demodulation mode and filter bandwidth.

HOLD TIME – Time in seconds to hold on a signal.

SQUELCH THRESHOLD – The frequency scanner uses the power meter to determine whether a signal is greater than the specified threshold value or not. The power meter measures the total power within the SP2 filter bandwidth. It is important to understand that the noise floor measured by the power meter is not the same as the visual indication of the noise floor shown on the SP1 display. This is because the visual indication of the noise floor is determined by the resolution bandwidth (RBW) of the SP1 FFT which is typically a lot lower than the SP2 filter bandwidth. To set the Threshold value correctly to provide accurate scanning, firstly, set the VFO to a quiet region (no signals) of the spectrum that you want to scan and note the noise level (in dBm) as indicated by the power meter. The power meter reading can be found in the SP1 display and to the right of the Frequency display in the Rx Control panel. Set a threshold value that is around 6-10 dB greater than the noise floor as indicated by the power meter. For example, if the power meter indicates a noise floor of -110 dBm, then set a threshold value of between -100 dBm and -104 dBm. This should minimise the chances of the frequency scanner falsely locking in regions where there are in fact no real signals.

Note: A memory scan will apply the memory panels threshold value if specified, if not it will use the global threshold value entered in the scanner config panel settings.

The squelch threshold can be modified by either entering a value in the scanner config panel or adjusting the squelch slider in the VRX0 RX Control panel.

WAIT ON SIGNAL – The scan is paused until the signal drops below the specified threshold and then the scan will continue.

SAVE TO MEMORY PANEL - Stores found frequencies into a selected bank within the memory panel.

VIEW SQUELCH THRESHOLD – Enables a Yellow horizontal line on the Main SP in relation to the dBm value entered in the SQUELCH THRESHOLD box or from the adjustment of the squelch slider in the Rx control panel.

CONT. LOOP – Continue a scan until the Stop button is pressed.

LOG STATISTICS – When enabled, captures key data from a memory scan or range scan. The statistics output file will reside in the %appdata%\SDRplay folder and is accessible via the MAIN panel options (OPT button). The text files created from a statistics capture is memory_scan.txt and range_scan.txt

MEM SCAN logs: Start and Stop time, Start and Stop Date, Frequency, Description, Modulation and Power level in dBm.

RANGE SCAN logs: Start date and time, Stop date and time, Frequency and Power level in dBm.

5.1 Scanning a list of frequencies (Memory Scan)



1: Open the memory panel (Main panel, MEM PAN)

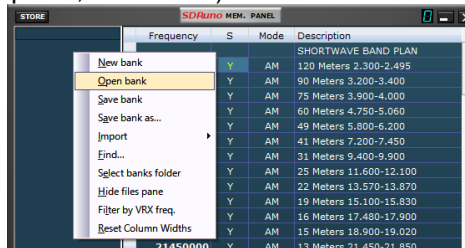

2: Open a prepopulated memory bank file (right-click within the memory panel)

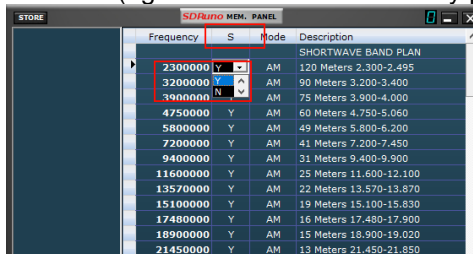

3: Within a loaded memory bank you will see a cell labelled with S. You can mark each frequency in the list with a Y or N (Yes or No) This will instruct the scanner to include or bypass that frequency in a memory bank scan.

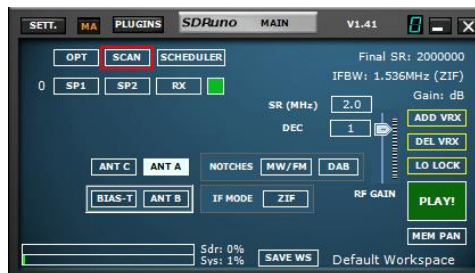

4: Open the Scanner panel. (Main panel, SCANNER)



5: Click the MEM button followed by the Green Play button. Please note, when scanning a memory bank, you can pause or stop the scan via the pause and stop buttons within the Scanner panel. Note that as of 1.42 0720, band framing is not supported for a memory panel scan. If band frame is enabled, a message will appear explaining that this is not compatible with an option to automatically disable the band frame and continue with the memory scan.

5.2 Range Scan



1: Open the Scanner panel. (Main panel, SCANNER)

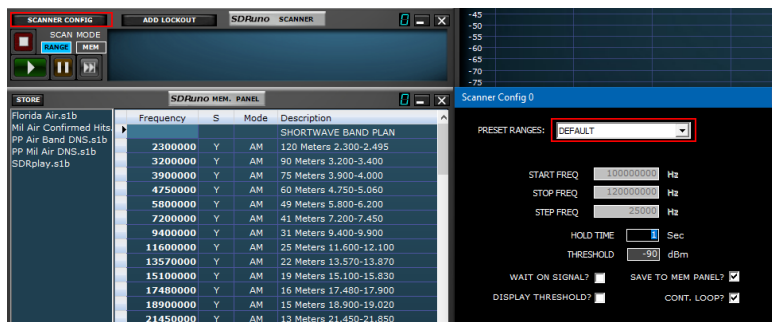

2: Click the RANGE button followed by the SCANNER CONFIG button. Select one of the preset ranges within the drop-down menu.

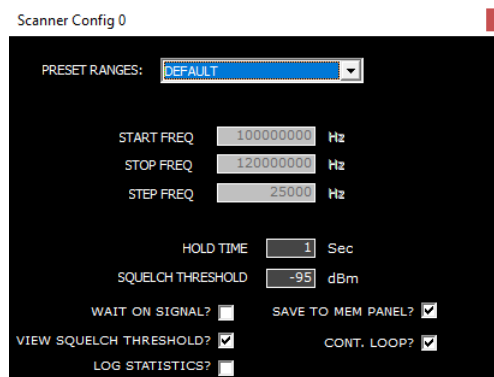

3: You can adjust or enable the following parameters when scanning a preset range. HOLD TIME, WAIT ON SIGNAL, SAVE TO MEM PANEL, VIEW SQUELCH THRESHOLD, CONT. LOOP, and LOG STATISTICS.

5.3 Custom Range Scan



1: Open the Scanner panel. (Main panel, SCANNER)

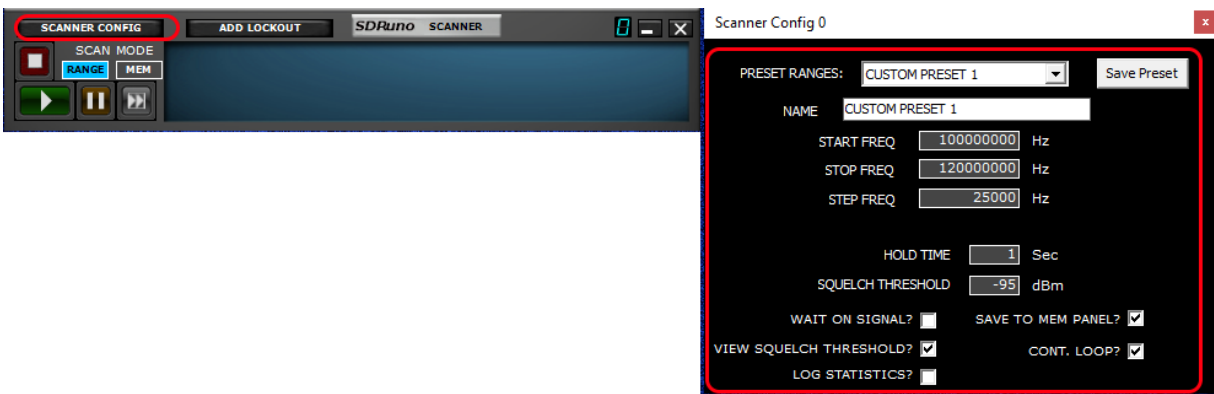

2: Click the RANGE button followed by the SCANNER CONFIG button. Select one of the user preset ranges (CUSTOM PRESET 1-8) within the drop-down menu. Edit the custom preset name. The demodulation mode and sub mode must be set before pressing the Save Preset button.

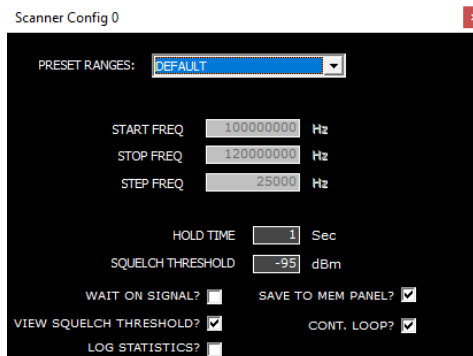

3: Enter the start and stop frequency range in Hz. You can also use m (MHz) or k (kHz) on the keyboard when entering the frequency. Apply the correct step frequency and adjust the threshold and wait time as needed. You can also adjust the following parameters when scanning a custom preset range. HOLD TIME, THRESHOLD, WAIT ON SIGNAL, DISPLAY THRESHOLD, SAVE TO MEM PANEL and CONT. LOOP.

WARNING: Check whether band framing is in use before starting the scanner. Unframe the band if so, to run the scanner using the optimum sample rate. The only time you would want to leave band framing enabled is if you are scanning within that band.

5.4 Scanner Statistics

Starting in 1.42 0720, scanner statistics will be saved to a standard CSV file for viewing or additional external processing. To enable the statistics output, select the LOG STATISTICS checkbox in the Scanner Configuration window. When scanner logging is enabled in either a range scan or a memory scan, the scanner statistics files will be saved to the %appdata%\SDRplay folder. This folder is quickly accessible from the SDRuno Main panel options dropdown menu (Data Directory).

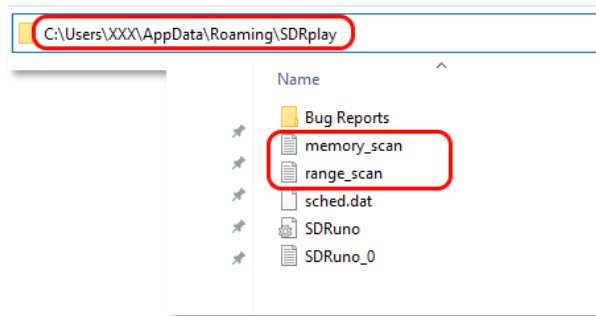
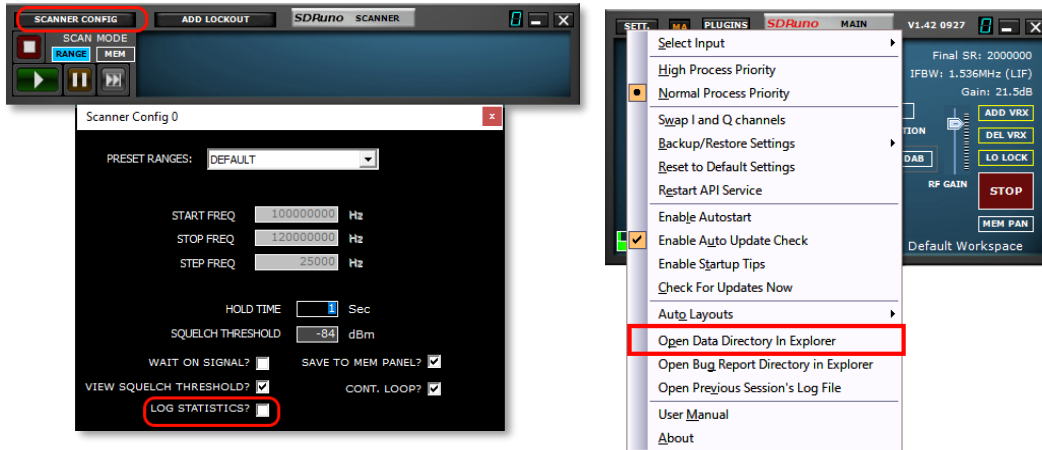

Range scan scanner statistics captures: Start Date/Time, Stop Date/Time, Frequency and Power Level in dBm

```

range_scan Notepad
File Edit Format View Help
Start Date/Time,Stop Date/Time,Frequency,Power Level (dBm)
7/16/2022 18:11:07,7/16/2022 18:11:08,570000,-108
7/16/2022 18:11:08,7/16/2022 18:11:09,590000,-109
7/16/2022 18:11:09,7/16/2022 18:11:10,660000,-108
7/16/2022 18:11:10,7/16/2022 18:11:11,690000,-116
7/16/2022 18:11:12,7/16/2022 18:11:12,700000,-110
7/16/2022 18:11:13,7/16/2022 18:11:14,720000,-113
7/16/2022 18:11:14,7/16/2022 18:11:15,730000,-117
7/16/2022 18:11:15,7/16/2022 18:11:16,770000,-107
7/16/2022 18:11:16,7/16/2022 18:11:17,820000,-107
7/16/2022 18:11:17,7/16/2022 18:11:18,850000,-110
7/16/2022 18:11:19,7/16/2022 18:11:20,990000,-109
7/16/2022 18:11:20,7/16/2022 18:11:21,1000000,-111
7/16/2022 18:11:21,7/16/2022 18:11:22,1040000,-112
7/16/2022 18:11:22,7/16/2022 18:11:23,1160000,-117
7/16/2022 18:11:23,7/16/2022 18:11:24,1170000,-118
7/16/2022 18:11:25,7/16/2022 18:11:26,1310000,-109
7/16/2022 18:11:26,7/16/2022 18:11:27,1480000,-118
7/16/2022 18:11:27,7/16/2022 18:11:28,1490000,-118
7/16/2022 18:11:29,7/16/2022 18:11:30,1700000,-113
7/16/2022 18:11:30,7/16/2022 18:11:31,570000,-116
7/16/2022 18:11:31,7/16/2022 18:11:32,620000,-111
7/16/2022 18:11:32,7/16/2022 18:11:33,660000,-108
7/16/2022 18:11:34,7/16/2022 18:11:35,690000,-116
7/16/2022 18:11:35,7/16/2022 18:11:36,700000,-110
7/16/2022 18:11:36,7/16/2022 18:11:37,730000,-117
Ln 1, Col 1 100% Unix (LF) UTF-8

```

Memory scan scanner statistics captures: Start Date/Time, Stop Date/Time, Frequency, Description, Modulation and Power Level in dBm

```

memory_scan Notepad
File Edit Format View Help
Start Date/Time,Stop Date/Time,Frequency,Description,Modulation,Power Level (dBm)
7/16/2022 18:09:22,7/16/2022 18:09:22,570000,KLIF,AM,-107
7/16/2022 18:09:30,7/16/2022 18:09:30,620000,KEXB,AM,-111
7/16/2022 18:09:34,7/16/2022 18:09:34,660000,KSXY,AM,-108
7/16/2022 18:09:38,7/16/2022 18:09:38,700000,KHSE,AM,-110
7/16/2022 18:09:41,7/16/2022 18:09:41,730000,KKDA,AM,-116
7/16/2022 18:09:44,7/16/2022 18:09:44,770000,KAAM,AM,-95
7/16/2022 18:09:48,7/16/2022 18:09:48,820000,WBAP,AM,-107
7/16/2022 18:09:55,7/16/2022 18:09:55,990000,KFCD,AM,-109
7/16/2022 18:09:59,7/16/2022 18:09:59,1160000,KBDT,AM,-117
7/16/2022 18:10:02,7/16/2022 18:10:02,1310000,KTCK,AM,-111
7/16/2022 18:10:07,7/16/2022 18:10:07,1480000,KBXD,AM,-117
7/16/2022 18:10:10,7/16/2022 18:10:10,570000,KLIF,AM,-107
7/16/2022 18:10:24,7/16/2022 18:10:25,570000,KLIF,AM,-118
7/16/2022 18:10:25,7/16/2022 18:10:26,660000,KSXY,AM,-118
7/16/2022 18:10:27,7/16/2022 18:10:28,770000,KAAM,AM,-108
7/16/2022 18:10:28,7/16/2022 18:10:29,820000,WBAP,AM,-117
7/16/2022 18:10:29,7/16/2022 18:10:30,990000,KFCD,AM,-116
7/16/2022 18:10:30,7/16/2022 18:10:31,1310000,KTCK,AM,-115
7/16/2022 18:10:32,7/16/2022 18:10:33,660000,KSXY,AM,-118
7/16/2022 18:10:33,7/16/2022 18:10:34,770000,KAAM,AM,-108
7/16/2022 18:10:34,7/16/2022 18:10:35,820000,WBAP,AM,-116
7/16/2022 18:10:36,7/16/2022 18:10:37,990000,KFCD,AM,-116
7/16/2022 18:10:37,7/16/2022 18:10:38,1310000,KTCK,AM,-114
7/16/2022 18:10:38,7/16/2022 18:10:39,1480000,KBXD,AM,-118
7/16/2022 18:10:40,7/16/2022 18:10:41,770000,KAAM,AM,-107
7/16/2022 18:10:41,7/16/2022 18:10:42,820000,WBAP,AM,-117
Ln 1, Col 1 100% Unix (LF) UTF-8

```

6 - IQ Audio Output



IQ OUT mode is a special mode whereby the filtered I/Q signal selected by the VFO is piped directly to the audio output bypassing the demodulation function. This function can be useful for interfacing to third party decoding applications such as CW Skimmer. The I-channel is piped to the Left Audio channel and the Q-channel is piped to the Right Audio channel. Preset sample rates of up to 192 kHz are possible via the WFM bandwidth sub-mode option and as low as 10 kHz are possible via the NFM bandwidth sub-mode option. It is not possible to set I/Q output rates that are greater than the input 'Final SR' as indicated in the top right-hand corner of the Main Panel. The most effective use of IQ Out is when used in conjunction with a third-party Virtual Audio Cable such as VAC or VB Audio HIFI to route the I/Q data to the third-party decoder applications.

7 - Audio Limiters



The SDRplay audio system is optimised for the best sound quality. This implements several filters and limiters in the audio path. If measurements of the audio path are needed, the filters and limiters can be disabled by unchecking this option. Care will be needed as the audio level is now no longer limited; however, measurements can now be made at the audio output.

8 - IF AGC controls

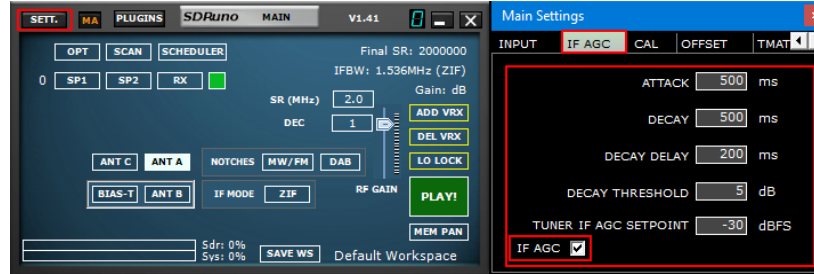

SDRuno 1.3 saw the introduction of an updated API with an improved IF AGC scheme. This has more configuration and allows you to better condition the IF AGC to their signal environment. Further improvements to better align the gain change with the correct point in the IQ stream has also helped to remove the bouncing effect that was seen in previous versions

Attack ms - Time taken for the AGC to reach 95% of the target value after an increase in the signal power

Decay ms - Time taken for the AGC to reach 95% of the target value after a reduction in the signal power

Decay Delay ms - Amount by which the power level has to fall before the decay delay timer is activated

Decay Threshold (dB) - Time after the power levels has reduced by an amount \geq to the decay threshold, before the AGC loop starts the decay process.

Tuner IF AGC Setpoint (dBfs) - Sets the target level power at which AGC routine will attempt adjust the power on the ADC input. A larger value will position the signal near the top of the ADC range. A lower value will reduce the signal power and hence levels at the ADC input.

If the IF AGC is disabled by checking the IF AGC box then IF AGC : Disabled will be displayed on the Main panel.

9 - PWR & SNR to CSV

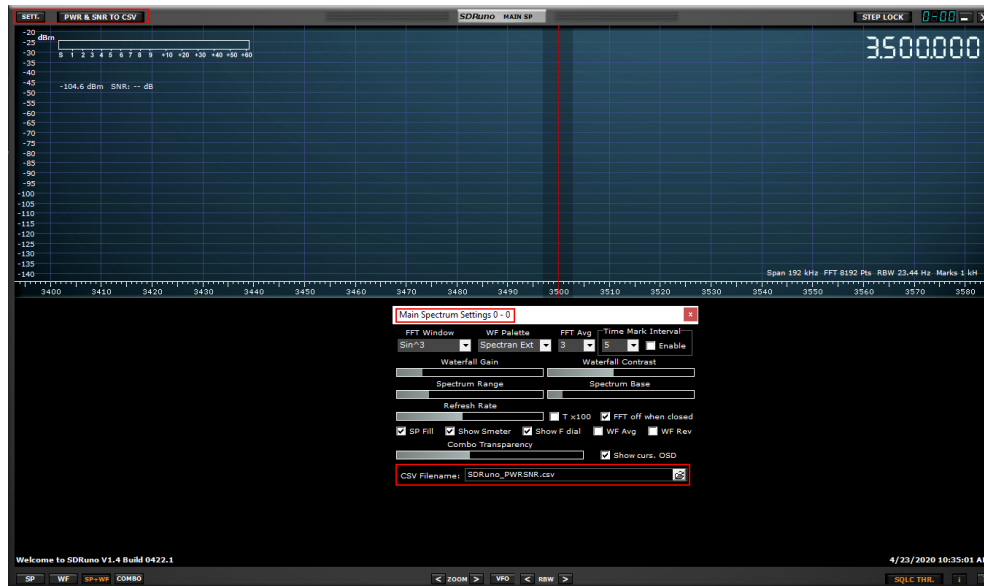

Power and signal to noise ratio measurements of the signal selected by the current VFO can be output to a standard CSV file for external processing by clicking on the PWR & SNR TO CSV button. The timing of each reading of the signal selected by the current VFO can be defined from the Time Mark Interval (in seconds). The location of the recording can be defined from the CSV filename box. Both variables can be changed from the MAIN SP settings button. The minimum time step resolution is 1 second.

Note: The power to csv function will only operate when the waterfall is displayed (MAIN SP)

10 - Automatic Band Framing



When pressing one of the band framing buttons in the RX CONTROL panel, the band button selected will light up green enabling the following: Locking of the LO, auto adjustment of the sample rate and decimation value along with the correct RX mode for the band selected. The MAIN SP panel will now “frame” the complete frequency range of the band chosen.

Unframing the band is done by simply clicking on the band framing button you selected. The green band framing light will go off and the sample rate will be restored 2 MHz and decimation will be 1. Unframing a band also unlock the LO.

Decimation is not available when a band is framed. Bands wider than 10 MHz cannot be framed, so in this instance, the LO LOCK is disengaged and the VFO is set to the centre of the band.



Left or right clicking on the “Bands” button will bring up the additional band segment presents.



Ham Lower: 2200m, 630m, 160m, 80m, 60m, 40m, 30m, 20m, 17m & 15m.

Ham Upper: 12m, 10m, 6m, 4m, 2m, 1.25m, 70cm, 33cm, & 23cm.

Broadcast: 75m, 60m, 41m, 31m, 25m, 22m, 19m, 16m, LW & MW

HDR: (RSPdx ONLY): 2200m, 630m, 160m, LOW (up to 500 kHz), FULL (up to 1.7 MHz), LFER (LF Experimental), NDBL (NDB Lower), NDBH (NDB Higher), LW & MW

Custom: 10 custom defined buttons from 1 KHz to 2 GHz with a maximum frequency span of 10 MHz and a minimum frequency span of 62.5 KHz. Notch filters (MW,FM, and DAB) are not applied.

Note: The MW notch filter is enabled for preset bands framed between 2 and 30 MHz (This is RSP dependent).

10.1 – Band Framing Customization

To define a custom band, click the Bands button. A drop-down menu will appear. Select custom in the drop-down menu.

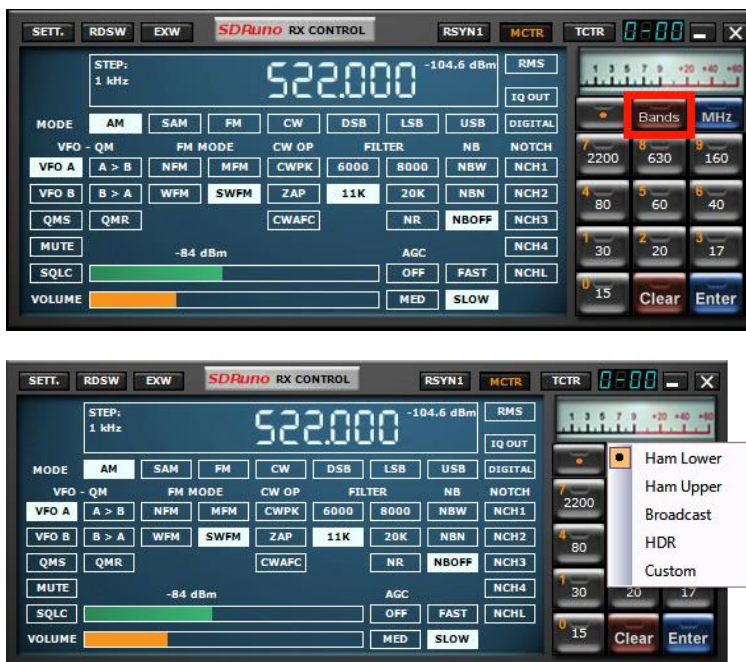

Right click one of the 10 buttons you wish to customize.



Enter the Low and High Frequency in Hz. Give the button a meaningful name (up to 4 characters). Click the OK button to save the custom defined band button.

Note: The 10 custom defined bands buttons high and low frequencies can be anywhere from 1 kHz to 2 Ghz. The maximum frequency span is 10 MHz. The minimum frequency span is 62.5 KHz. Notch filters (MW,FM, and DAB) are not applied. A reset to defaults will clear all defined custom band buttons. Individual custom band buttons can be redefined but not cleared.

Custom band framing is only supported in Zero IF (ZIF) mode and NOT in Low IF (LIF) mode. For this reason, custom band framing is not supported in either Diversity or Master/Slave modes of the RSPduo.

NOTE: Many the regular band frame buttons use Low-IF mode, so to go from that band framing to a custom band frame, unframe the band and then make sure ZIF mode is selected first.

11 - Other SDRuno Features and Functions

11.1 Synchronous AM

SDRuno implements a high-performance SAM mode. When you select SAM the last used sub-mode is also recalled (LSB, USB or DSB). Once SAM is engaged you can switch to the desired sub-mode by clicking the relative buttons:

- LSB: lower sideband SAM
- USB: higher sideband SAM
- DSB: double sideband SAM

LSB and USB SAM sub-modes share the same selectivity filter settings while DSB has its own settings. Some common filter settings are available as presets in the RX Control window. Of course you can set the filter manually

Automatic volume compensation is performed while switching from LSB or USB to DSB. To leave SAM mode you can either click on the SAM button again (this will select the last used SSB mode) or select any other reception mode.



In SDRuno the SAM PLL has its own AGC and selectivity filter. There are many advantages in using this configuration:

- The demodulation AGC timing can be optimized for listening while a much faster PLL AGC can cope with fast, deep fading
- The PLL selectivity filter can be made very narrow to allow only the wanted carrier passing thru; this way little noise reaches the PLL and the lock on noisy signal is much improved

The PLL step response can be set to two different modes:

- FAST: this is the default mode; in "fast" mode the PLL can track phase-modulated carriers that contain embedded data streams (for example BBC on 198 KHz), avoiding the demodulation of those noisy unwanted signals. Lock time is fast even if you are off tune, but the PLL is also more sensitive to noise given the wider loop bandwidth.
- SLOW: this is the DX choice; lock time is slower and the PLL is much more immune to noise. This mode combined with a narrow PLL BW filter setting gives exceptional lock stability on very noisy signals.

Locking range is limited with this setting: if this is a problem, first select FAST mode then switch to SLOW if required.

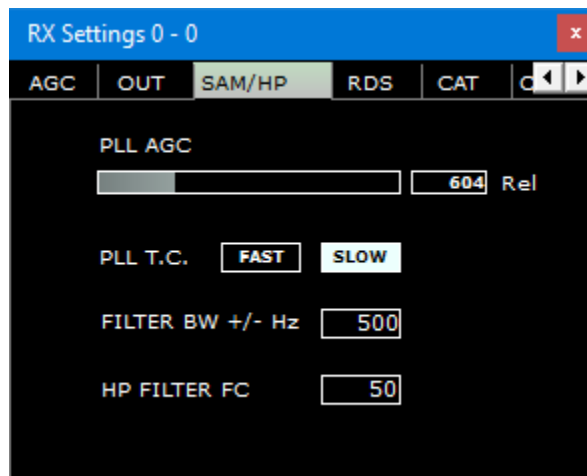

The pre-PLL pass-band filter can be adjusted from +/- 50 Hz to the full bandwidth available. Please note that this setting also limits the range in which the PLL can achieve lock: for example, if you are using a 500 Hz setting (default) and you tune outside the +/- 500 Hz from the carrier, the PLL will never lock as the carrier is filtered out.

All the PLL AGC parameters are pre-fixed for best results minus the release time. This parameter can be optimized for the specific reception condition; usually the default value works well.

All the SAM settings are available in RX Control->Settings->SAM/HP Tab.

11.2 S-Meter function



When used with any RSP the S-Meter is accurately calibrated. In order to change from the S-Meter function to FM tuning and vice versa, simply click on it. By default, the IARU region 1 settings are used. In this mode, S9 = -73 dBm for frequencies up to 30 MHz and S9 = -93 dBm for frequencies above 30 MHz. This setting can be changed in the Main Panel Settings menu.

11.3 Quick notch frequency setting and the notch-lock function



Each VRX offers four notch filters to suppress unwanted signals, placed before the audio AGC. Each notch filter can be enabled/disabled by the relevant button in the RX Control panel. The notch filters bandwidth & frequency settings are available in the RX EX Control panel. For notch filters 1 & 2 the frequencies can be quickly set "on the fly" as follows:

- Place the cursor in the spectrum part of the Aux Spectrum panel (SP2); press and hold the SHIFT key: a yellow vertical line will be shown at cursor position.
- Move the above line next to the signal you wish to suppress.
- Assign that frequency to Notch 1 by Left-Click or Notch 2 by Right-Click.
- Release the SHIFT key.
- For each enabled notch the relative frequency is marked in the spectrum by a dotted vertical line, light-blue for Notch 1 and light-pink for Notch 2.

The **NCHL** button in the RX Control panel enable/disable the notch-lock feature. When notch-lock is active, the notch filters frequencies remain fixed when the VFO is changed until the notch frequency relative to the VFO is outside of the SP2 displayed bandwidth.

11.4 RDS



SDRuno features a totally re-designed RDS demodulation processing, from filtering to bit-stream extraction. Also, a new “DX mode” feature has been added to the RDS decoder. The new RDS processing offers “state of the art” performances, very close to the theoretical limits. Testing has shown that it is still possible to obtain a valid RDS PI from a signal with only a 10 dB S/N ratio.



RDS demodulation/decoding works in WFM and SWFM modes. There are two operation modes for the RDS system: OFF and Mode1 . You can select a specific mode for a VRX in the RX Control->SETT.->RDS window.

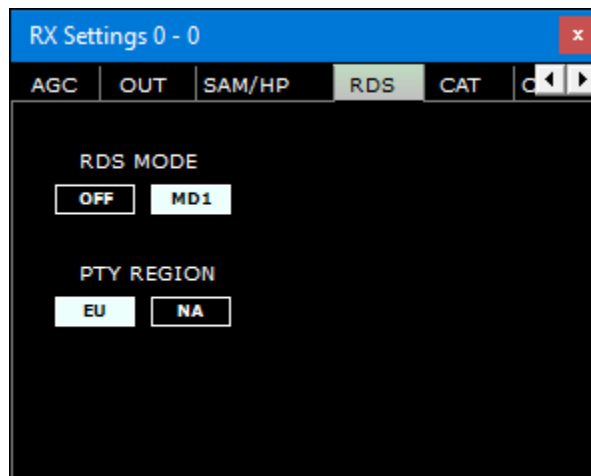

Off: the entire RDS sub-system is shut down; this can be useful to save CPU.

MD1: the demodulator directly locks a special PLL to the 57 KHz RDS sub-carrier to extract the modulating bi-phase signal. This allows for RDS reception of any kind of signals, including mono, providing they contain a valid RDS modulation.



RDS data is transmitted in pieces called “RDS groups” and each group is composed of four “RDS blocks”. To obtain valid data the RDS decoder must achieve “synchronization” first; this means that a correct sequence of blocks “A” to “D” must be validated by the embedded error correction system. In very poor S/N ratio (approximately below 11-12 dB) this is impossible.

In normal use this is usually not a great concern but for DX enthusiast it is, as the main goal is the identification of the broadcaster by the RDS PI data. PI data is embedded at least in all “Block A” of any RDS groups so it is one of the more redundant pieces of information transmitted. In RDS “DX-mode” Studio 1 tries to extract the PI by attempting a partial synchronization, then the relative PI data is shown in red.

The level of confidence is very high (> 99.5%). The RDS decoder exits “DX-mode” once full synchronization is achieved and the PI label returns to its normal state. In order to re-enter DX-mode you have to reset the decoder by the RESET button in the RDS Info window. For marginal signals DX-mode can be a very useful tool.

12 - Memory Panel

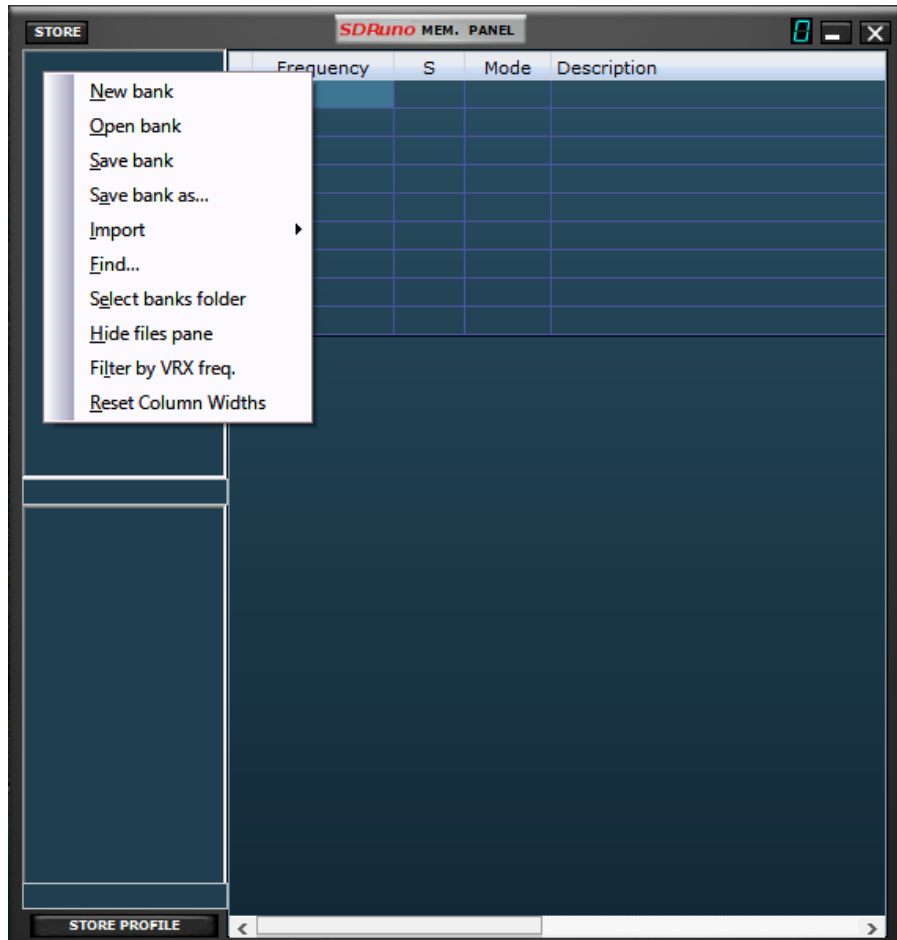

12.1 Basic concepts



The screenshot shows the 'SDRplay MEM. PANEL' window with a populated table. The table has columns for Frequency, S, Mode, Description, UTC, SubM, Filter, Port, and Threshold. The left sidebar shows a list of bank files, with 'AMATEUR RADIO.s1b' selected.

Bank File	Frequency	S	Mode	Description	UTC	SubM	Filter	Port	Threshold
AMATEUR RADIO.s1b				AMATEUR RADIO-Mike SDRplay-2022					
AVIATION.s1b									
BEACONS.s1b									
CB.s1b									
EIABI-BC-A22.s1b				BANDPLAN-UNITED STATES					
FRS & GMRS.s1b	1800000	Y	LSB	160 Meters 1.800-2.000			2800	AntC	
HF BROADCAST.s1b	3500000	Y	LSB	80 Meters 3.500-4.000			2800	AntC	
LBAND-1.s1b	7000000	Y	LSB	40 Meters 7.000-7.300			2800	AntC	
LBAND-2.s1b	10100000	Y	USB	30 Meters 10.100-10.150			2800	AntC	
LBAND-3-INMARSAT.s1b	14000000	Y	USB	20 Meters 14.000-14.350			2800	AntC	
MARINE.s1b	18068000	Y	USB	17 Meters 18.068-18.168			2800	AntC	
MEDIUM WAVE.s1b	21000000	Y	USB	15 Meters 21.100-21.450			2800	AntC	
MILITARY.s1b	24890000	Y	USB	12 Meters 24.890-24.990			2800	AntC	
SATELLITE-1.S1B	28000000	Y	USB	10 Meters 28.000-29.700			2800	AntC	
SATELLITE-2.S1B									
SPACE.s1b									
TIME.s1b									
WEFAX.s1b				FT8					
WX-NOAA.s1b	1840000	Y	USB	FT8 160m			3000	AntC	
AMATEUR RADIO.s1b	3573000	Y	USB	FT8 80m			3000	AntC	
	5357000	Y	USB	FT8 60m			3000	AntC	
	7074000	Y	USB	FT8 40m			3000	AntC	

In SDRuno each memory bank consists of a number of “memory locations”. Each memory location is composed of a number of data fields about a “reception channel” like frequency, description, RX mode and so on. Physically a bank is saved as a disk file and loaded in memory when needed.

12.2 The memory bank file format

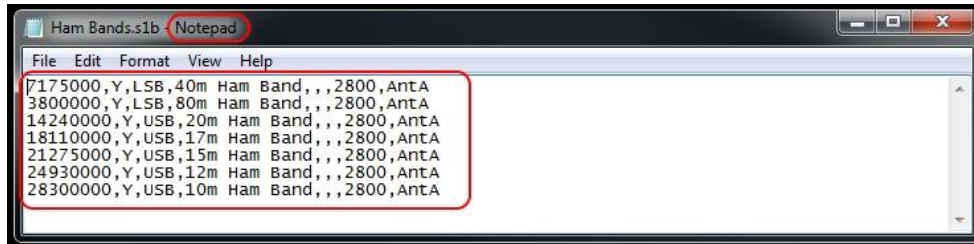

SDRuno uses its own extension (s1b) for memory bank files but the file format itself is not proprietary: it is a common CSV text file, a format that can be easily handled by many software tools. Warning: reading a s1b file into SDRuno with the incorrect format is likely to cause problems.

12.3 GUI items for memory banks management



- “MEM PAN” in the Main Panel will open the memory panel
- “MCTR” in the RX Control Panel will assign control of the memory panel to the specific VRX

12.4 The "Memory" Panel

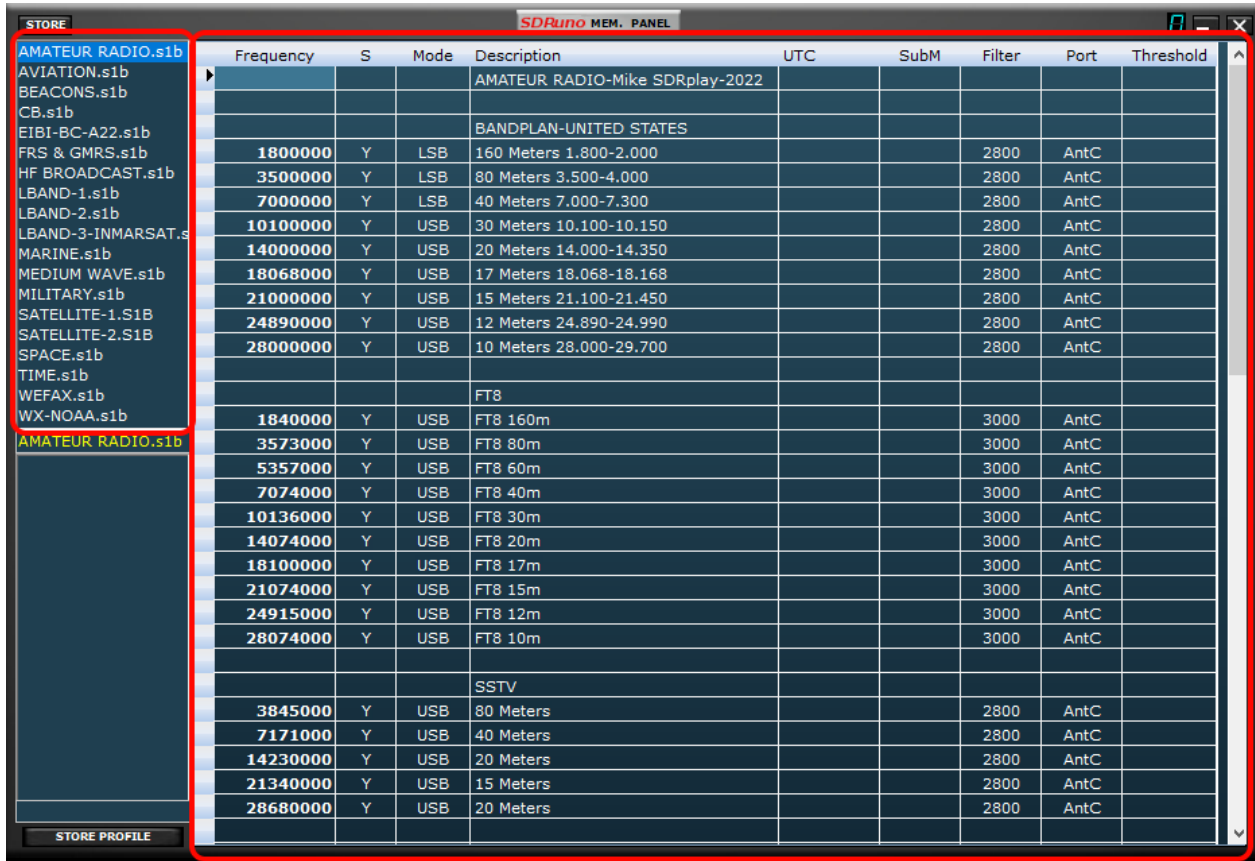

Frequency	S	Mode	Description	UTC	SubM	Filter	Port	Threshold
			AMATEUR RADIO-Mike SDRplay-2022					
			BANDPLAN-UNITED STATES					
1800000	Y	LSB	160 Meters 1.800-2.000			2800	AntC	
3500000	Y	LSB	80 Meters 3.500-4.000			2800	AntC	
7000000	Y	LSB	40 Meters 7.000-7.300			2800	AntC	
10100000	Y	USB	30 Meters 10.100-10.150			2800	AntC	
14000000	Y	USB	20 Meters 14.000-14.350			2800	AntC	
18068000	Y	USB	17 Meters 18.068-18.168			2800	AntC	
21000000	Y	USB	15 Meters 21.100-21.450			2800	AntC	
24890000	Y	USB	12 Meters 24.890-24.990			2800	AntC	
28000000	Y	USB	10 Meters 28.000-29.700			2800	AntC	
			FT8					
1840000	Y	USB	FT8 160m			3000	AntC	
3573000	Y	USB	FT8 80m			3000	AntC	
5357000	Y	USB	FT8 60m			3000	AntC	
7074000	Y	USB	FT8 40m			3000	AntC	
10136000	Y	USB	FT8 30m			3000	AntC	
14074000	Y	USB	FT8 20m			3000	AntC	
18100000	Y	USB	FT8 17m			3000	AntC	
21074000	Y	USB	FT8 15m			3000	AntC	
24915000	Y	USB	FT8 12m			3000	AntC	
28074000	Y	USB	FT8 10m			3000	AntC	
			SSTV					
3845000	Y	USB	80 Meters			2800	AntC	
7171000	Y	USB	40 Meters			2800	AntC	
14230000	Y	USB	20 Meters			2800	AntC	
21340000	Y	USB	15 Meters			2800	AntC	
28680000	Y	USB	20 Meters			2800	AntC	

There is only one **Memory panel** per SDRuno instance. The panel is resizable, and its visibility parameters are stored in the workspace. To show the Memory panel click on the **MEM PAN** button on the **Main** panel or press the **B** key from any panel of the program.

The Memory panel is functionally split in two parts: the left part, also called the **files pane** and the right part also called the **data grid**. The files pane is split into an upper half and a lower half. The lower half is where saved profiles are listed (see section 12.14). The upper half displays all the bank files in the current banks folder; you can quickly open one of the listed banks by double-clicking its name.

On the bottom of the list a label shows the name of the currently loaded bank. The files pane can be hidden/shown with the **CTRL+F** keyboard shortcut or from the panel context menu (mouse right-click); this setting is persistent (saved in the ini file).

The **data grid** is the key control: here the current bank data is shown in **cells** organized in **rows** (the memory locations) and **columns** (the data fields).

12.5 Memory data fields



	Frequency	S	Mode	Description	UTC	SubM	Filter	Port	Threshold
AMATEUR RADIO.s1b				AMATEUR RADIO-Mike SDRplay-2022					
AVIATION.s1b									
BEACONS.s1b									
CB.s1b									
EIBI-BC-A22.s1b				BANDPLAN-UNITED STATES					
FRS & GMRS.s1b	1800000	Y	LSB	160 Meters 1.800-2.000			2800	AntC	
HF BROADCAST.s1b	3500000	Y	LSB	80 Meters 3.500-4.000			2800	AntC	
LBAND-1.s1b	7000000	Y	LSB	40 Meters 7.000-7.300			2800	AntC	
LBAND-2.s1b									
LBAND-3-INMARSAT.s	10100000	Y	USB	30 Meters 10.100-10.150			2800	AntC	
MARINE.s1b	14000000	Y	USB	20 Meters 14.000-14.350			2800	AntC	
MEDIUM WAVE.s1b	18068000	Y	USB	17 Meters 18.068-18.168			2800	AntC	
MILITARY.s1b	21000000	Y	USB	15 Meters 21.100-21.450			2800	AntC	
SATELLITE-1.S1B	24890000	Y	USB	12 Meters 24.890-24.990			2800	AntC	
SATELLITE-2.S1B	28000000	Y	USB	10 Meters 28.000-29.700			2800	AntC	
SPACE.s1b									
TIME.s1b									
WEFAX.s1b				FT8					
WX-NOAA.s1b	1840000	Y	USB	FT8 160m			3000	AntC	
AMATEUR RADIO.s1b	3573000	Y	USB	FT8 80m			3000	AntC	
	5357000	Y	USB	FT8 60m			3000	AntC	
	7074000	Y	USB	FT8 40m			3000	AntC	

Currently each memory location includes 8 data fields:

Frequency

This is the most important field of course; frequency is expressed in Hertz up to 10 digits. If left blank the program will not change the tuning frequency of the relative VRX upon recalling.

S (scan mode)

Its purpose is to instruct the Frequency Scanner whether to demodulate or skip the specified frequency. Allowed values are Y to demodulate the frequency and N to skip it.

Mode

This field indicates the **RX mode** for that memory location. Allowed values are: **blank, AM, SAM, FM, CW, DSB, LSB, USB, and USER**. If left blank the program will not change the RX mode of the relative VRX upon recalling.

Description

This field include an optional alphanumeric description of the memory location. The maximum length is undefined; however, the grid editor for this field limits the input to a maximum of 255 characters.

UTC

This field can optionally include a description of when the relative channel is on-air, a feature usually included in many frequency databases. The format is XXXX-YYYY where XXXX is the start time and YYYY the stop time (UTC time); for example, 0000-2400 means that the station is on air 24 hours a day.

SubM

Used if the selected mode has a sub mode (e.g. FM can be either NFM, MFM, WFM or SWFM).

Filter

At the time that the frequency is stored from within SDRUno, the selected filter bandwidth is also stored.

Port

If a multi-port RSP has been in use when the frequency was stored, it will be filled in here.

Threshold A memory scan will apply the memory panels threshold value if specified, if not it will use the global threshold value entered in the scanner config panel settings. Please see [section 5.1](#)

12.6 The data grid



The data grid has the main purpose of showing data, but it also provides many ways for editing. Inside the grid you can:

- Scroll the bank data with the mouse wheel, scrolling bars or up-down arrow keys.
- Customize the columns order.
- Insert (add), delete, move and copy/paste rows.
- Manually edit single cells.
- Copy-paste single cells and cell selections.
- Perform row sorting (ascending/descending) with a single click.
- Search for specific data (incremental search).
- Filter data

Selected data fields are shown in yellow.

The current active cell is highlighted with a brighter background.

The current active row is shown by a small arrow marker shown in the row header.

12.6.1 Customizing the columns order

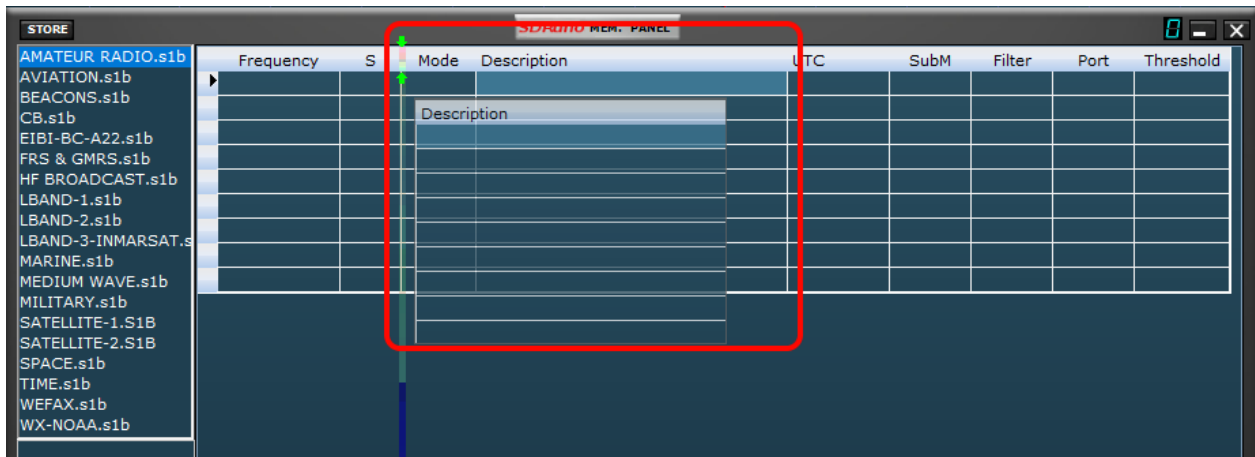

By default, the grid shows the columns in the same order as the relative data fields are stored in the bank file. However, you might want to change the columns display order. To move a column to a new position, click and drag the relative column header to the new position (a green arrow shows you the insertion point), then release the mouse button. Columns order is persistent (it is saved in the ini file).

12.6.2 Manual editing of cells



STORE	Frequency	S	Mode	Description	UTC	SubM	Filter	Port
AMATEUR RADIO.s1b				VOLMET-Mike SDRplay				
AVIATION.s1b								
CB.s1b				VOLMET-AVIATION WEATHER				
FRS & GMRS.s1b								
HF BROADCAST.s1b								
HFDL.s1b	2863000	Y	USB	TOKYO-HONG KONG			2800	Ant
LBAND-1.s1b	2869000	Y	USB	SIVKAR-NOVOSIBIRSK-SAMARA			2800	Ant
LBAND-2.s1b	2881000	Y	USB	EZEIZA			2800	Ant
MARINE.s1b	2899000	Y	USB	COMODORO			2800	Ant
MILITARY.s1b	2941000	Y	USB	ROSTOV			2800	Ant
MW.s1b	2965000	Y	USB	KOLKATA-BANGKOK-KARACHI-MUMBAI			2800	Ant
MWARA.s1b	2978000	Y	USB	CORDOBA			2800	Ant
NOAA WX.s1b	3413000	Y	USB	SHANNON			2800	Ant
ODDITY.s1b	3458000	Y	USB	GUANGZHOU-BEIJING			2800	Ant
SATELLITE-1.S1B	3485000	Y	USB	GANDER			2800	Ant
SATELLITE-2.S1B	4657000	Y	USB	COMODORO			2800	Ant
SPACE.s1b	4675000	Y	USB	RESISTENCIA			2800	Ant
STANAG.s1b	4742000	Y	USB	VIPER (MOUNT PLEASANT)-CYPRUS			2800	Ant
VOLMET.s1b								

In order to start manual editing of a cell you have two options:

- Click on the relative cell then press **F2**.
- Double-click the cell.

The above operation starts the specific editor for that cell:

- The Frequency field editor allows up to 10 numeric characters.
- The Description field editor allows up to 255 alphanumeric characters.
- The Mode, Sub-mode, Filter, Port and S field editors are of the combo-list kind: upon pressing the combo button you are allowed to select one of the values in the drop-down list.
- The UTC field editor allows up to 9 alphanumeric characters.

To close the editor, press the Enter key (combo-list editors close automatically upon selection). If the entry is invalid the cell shows the previous data.

12.6.3 Manually inserting a new row



STORE	Frequency	S	Mode	Description	UTC	SubM	Filter	Port
AMATEUR RADIO.s1b				VOLMET-Mike SDRplay				
AVIATION.s1b								
CB.s1b				VOLMET-AVIATION WEATHER				
FRS & GMRS.s1b								
HF BROADCAST.s1b								
HFDL.s1b	2863000	Y	USB	TOKYO-HONG KONG			2800	Ant
LBAND-1.s1b	2869000	Y	USB	SIVKAR-NOVOSIBIRSK-SAMARA			2800	Ant
LBAND-2.s1b	2881000	Y	USB	EZEIZA			2800	Ant
MARINE.s1b	2899000	Y	USB	COMODORO			2800	Ant
MILITARY.s1b	2941000	Y	USB	ROSTOV			2800	Ant
MW.s1b	2965000	Y	USB	KOLKATA-BANGKOK-KARACHI-MUMBAI			2800	Ant
MWARA.s1b	2978000	Y	USB	CORDOBA			2800	Ant
NOAA WX.s1b	3413000	Y	USB	SHANNON			2800	Ant
ODDITY.s1b	3458000	Y	USB	GUANGZHOU-BEIJING			2800	Ant
SATELLITE-1.S1B	3485000	Y	USB	GANDER			2800	Ant
SATELLITE-2.S1B	4657000	Y	USB	COMODORO			2800	Ant
SPACE.s1b	4675000	Y	USB	RESISTENCIA			2800	Ant
STANAG.s1b								
VOLMET.s1b								

New rows are always inserted after the current one. To manually insert a new (blank) row press the “**Ins**” key.

12.6.4 Deleting a row



STORE	Frequency	S	Mode	Description	UTC	SubM	Filter	Port
AMATEUR RADIO.s1b								
AVIATION.s1b				VOLMET-Mike SDRplay				
CB.s1b								
FRS & GMRS.s1b								
HF BROADCAST.s1b				VOLMET-AVIATION WEATHER				
HFDL.s1b	2863000	Y	USB	TOKYO-HONG KONG			2800	Antd
LBAND-1.s1b								
LBAND-2.s1b	2869000	Y	USB	SIVKAR-NOVOSIBIRSK-SAMARA			2800	Antd
MARINE.s1b	2881000	Y	USB	EZEIZA			2800	Antd
MILITARY.s1b	2899000	Y	USB	COMODORO			2800	Antd
MW.s1b	2941000	Y	USB	ROSTOV			2800	Antd
MWARA.s1b	2965000	Y	USB	KOLKATA-BANGKOK-KARACHI-MUMBAI			2800	Antd
NOAA WX.s1b	2978000	Y	USB	CORDOBA			2800	Antd
ODDITY.s1b	3413000	Y	USB	SHANNON			2800	Antd
SATELLITE-1.S1B	3458000	Y	USB	GUANGZHOU-BEIJING			2800	Antd
SATELLITE-2.S1B	3485000	Y	USB	GANDER			2800	Antd
SPACE.s1b	4657000	Y	USB	COMODORO			2800	Antd
STANAG.s1b	4675000	Y	USB	RESISTENCIA			2800	Antd
VOLMET.s1b								

To delete the current row, press the **Del** key.

12.6.5 Moving a row



STORE	Frequency	S	Mode	Description	UTC	SubM	Filter	Port
AMATEUR RADIO.s1b								
AVIATION.s1b				VOLMET-Mike SDRplay				
CB.s1b								
FRS & GMRS.s1b								
HF BROADCAST.s1b				VOLMET-AVIATION WEATHER				
HFDL.s1b	2863000	Y	USB	TOKYO-HONG KONG			2800	Antd
LBAND-1.s1b	2869000	Y	USB	SIVKAR-NOVOSIBIRSK-SAMARA			2800	Antd
LBAND-2.s1b	2881000	Y	USB	EZEIZA			2800	Antd
MARINE.s1b	2899000	Y	USB	COMODORO			2800	Antd
MILITARY.s1b	2941000	Y	USB	ROSTOV			2800	Antd
MW.s1b	2965000	Y	USB	KOLKATA-BANGKOK-KARACHI-MUMBAI			2800	Antd
MWARA.s1b	2978000	Y	USB	CORDOBA			2800	Antd
NOAA WX.s1b	3413000	Y	USB	SHANNON			2800	Antd
ODDITY.s1b	3458000	Y	USB	GUANGZHOU-BEIJING			2800	Antd
SATELLITE-1.S1B	3485000	Y	USB	GANDER			2800	Antd
SATELLITE-2.S1B	4657000	Y	USB	COMODORO			2800	Antd
SPACE.s1b	4675000	Y	USB	RESISTENCIA			2800	Antd
STANAG.s1b	4742000	Y	USB	VIPER (MOUNT PLEASANT)-CYPRUS			2800	Antd
VOLMET.s1b								

To move a row to a new location, click and drag its header to the new location (a green arrow shows you the insertion point); finally release the mouse button.

12.6.6 Copying a row

If you don't want to overwrite a previous row, first insert a new blank row to be used as the destination one.

- Select the source row by clicking its header.
- Copy to clipboard by **CTRL+C** shortcut.
- Now click the row header of the destination row.
- Paste from clipboard by **CTRL+V** shortcut.

12.6.7 Copying a single cell

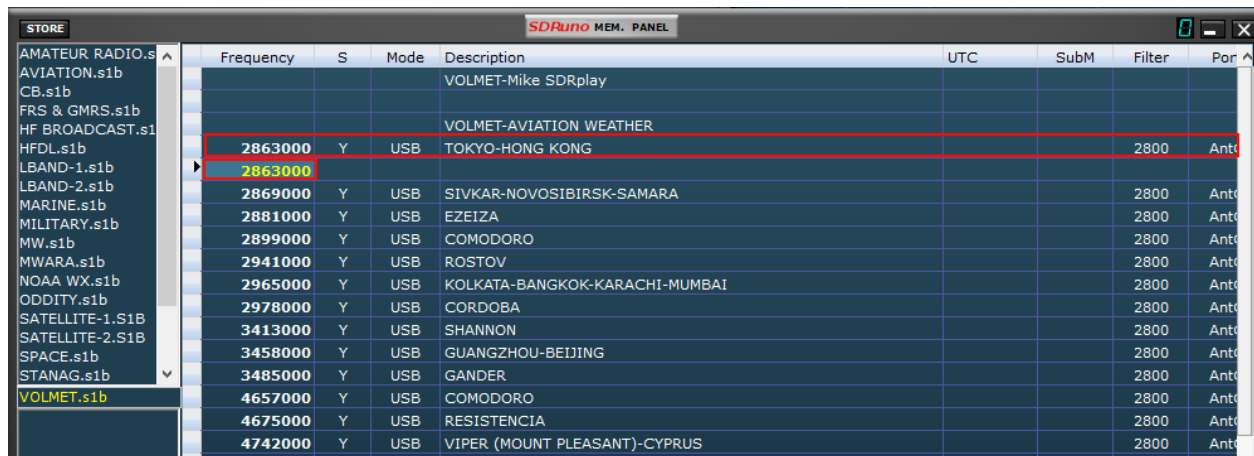

Frequency	S	Mode	Description	UTC	SubM	Filter	Port
			VOLMET-Mike SDRplay				
			VOLMET-AVIATION WEATHER				
2863000	Y	USB	TOKYO-HONG KONG			2800	Ant
2869000	Y	USB	SIVKAR-NOVOSIBIRSK-SAMARA			2800	Ant
2881000	Y	USB	EZEIZA			2800	Ant
2899000	Y	USB	COMODORO			2800	Ant
2941000	Y	USB	ROSTOV			2800	Ant
2965000	Y	USB	KOLKATA-BANGKOK-KARACHI-MUMBAI			2800	Ant
2978000	Y	USB	CORDOBA			2800	Ant
3413000	Y	USB	SHANNON			2800	Ant
3458000	Y	USB	GUANGZHOU-BEIJING			2800	Ant
3485000	Y	USB	GANDER			2800	Ant
4657000	Y	USB	COMODORO			2800	Ant
4675000	Y	USB	RESISTENCIA			2800	Ant
4742000	Y	USB	VIPER (MOUNT PLEASANT)-CYPRUS			2800	Ant

- Click on the source cell; copy to clipboard by **CTRL+C**.
- Click on the destination cell; paste from clipboard by **CTRL+V**.

12.6.8 Advanced editing operations



Frequency	S	Mode	Description	UTC	SubM	Filter	Port
			VOLMET-Mike SDRplay				
			VOLMET-AVIATION WEATHER				
2863000	Y	USB	TOKYO-HONG KONG			2800	Ant
2869000	Y	USB	SIVKAR-NOVOSIBIRSK-SAMARA			2800	Ant
2881000	Y	USB	EZEIZA			2800	Ant
2899000	Y	USB	COMODORO			2800	Ant
2941000	Y	USB	ROSTOV			2800	Ant
2965000	Y	USB	KOLKATA-BANGKOK-KARACHI-MUMBAI			2800	Ant
2978000	Y	USB	CORDOBA			2800	Ant
3413000	Y	USB	SHANNON			2800	Ant
3458000	Y	USB	GUANGZHOU-BEIJING			2800	Ant
3485000	Y	USB	GANDER			2800	Ant
4657000	Y	USB	COMODORO			2800	Ant
4675000	Y	USB	RESISTENCIA			2800	Ant
4742000	Y	USB	VIPER (MOUNT PLEASANT)-CYPRUS			2800	Ant

You can sort the loaded memory bank using any of the **data fields** as the main **sorting key**. To perform ascending sorting, click on the column header of the field you wish to use as the key. Click again to perform descending sorting. A further click undoes the sorting. An arrow indicator shows up in the column header used for sorting; it points upward to indicate an ascending sort and downward for a descending sort. A sorted bank can be saved in its state if needed.

12.6.9 Selecting and copying multiple cells

It is possible to copy multiple cells at a time; to perform a multi-cell selection click on the upper left cell and drag to the right lower cell of the selection area (selected text turn to yellow). Then you can copy and paste the entire selection using the clipboard shortcuts already seen (**CTRL+C**, **CTRL+V**).

12.7 Bank file operations

12.7.1 Changing the current Banks Folder



The default Banks Folder is the local system Documents folder.

To change the **Banks Folder**, pop up the context menu (right-click on the files pane or the grid) then choose **Select banks folder**; navigate to the new folder then click **OK**. The Banks Folder is persistent (it is saved in the ini file).

12.7.2 Opening a bank file



The quick way to open a bank file is by **double-clicking its name in the files pane**. Another option is by the context menu **Open bank** option.

The last bank opened is automatically reloaded at the next program start-up.

12.7.3 Saving a bank



To save an already named bank choose **Save bank** from the context menu. If the bank is new (unnamed), Save bank starts a **Save bank as...** operation instead (see below).

12.7.4 Saving a bank with a specific name

This is the usual Save as operation: choose **Save bank as...** from the context menu. A save window lets you name the file; if the file already exists a warning window pops-up.

12.7.5 Creating a new empty bank



To create a new, blank bank choose **New bank** from the context menu.

Caution: SDRuno will not prompt you with pop-up dialog asking if you have saved your data. So, if you made modifications to the current bank make sure to save it before creating a new one.

12.7.6 Searching the memory bank

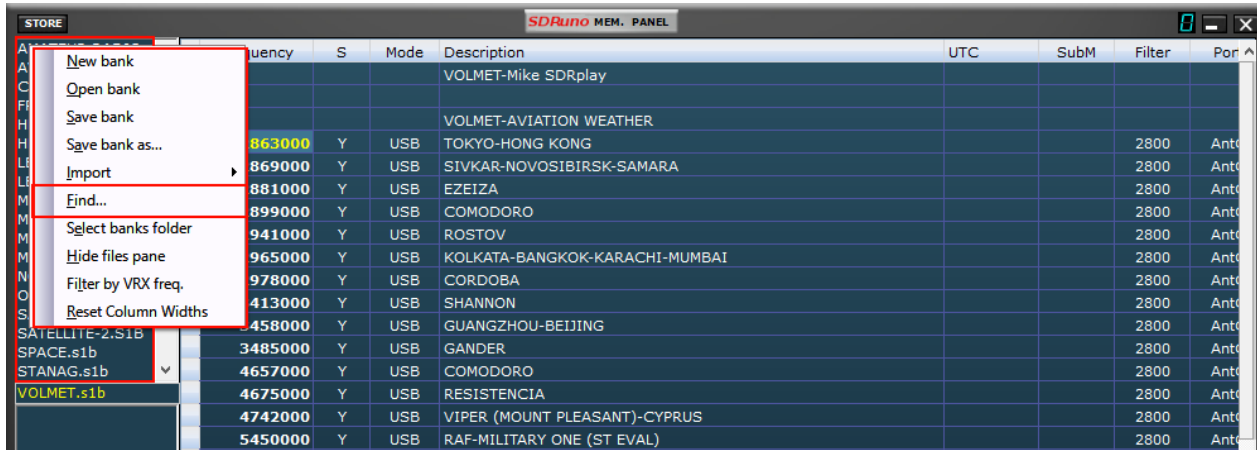

Sometimes you might have to search a large bank for a specific word occurrence. To activate the search function choose **Find...** from the context menu; a search footer appears. The search footer provides you with familiar functions to perform incremental search; as you type your text in the search edit box the search process refines. Use the **Next-Previous** buttons to navigate among multiple occurrences of the same word. Unless the Match case option is checked search is case-insensitive.

12.8 Recalling a memory location

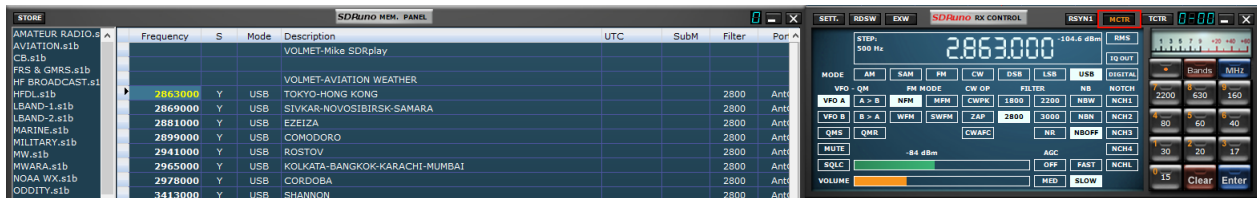

In this context recalling a memory location means assigning its Frequency and Mode parameters to a SDRuno VRX. As an instance of SDRuno can have more than one VRX you need a way to tell the Memory panel which is your “target” VRX: this is the purpose of the **MCTR** button on the RX Control panel. The MCTR button “connects” a specific VRX to the Memory panel for some operations. A mutual exclusion logic is implemented: only one VRX can be assigned at a given time (inside the same application instance). Once a VRX is “connected” recalling a memory location is straightforward: simply click on any cell of the wanted memory location (row).

12.9 Storing to a memory location

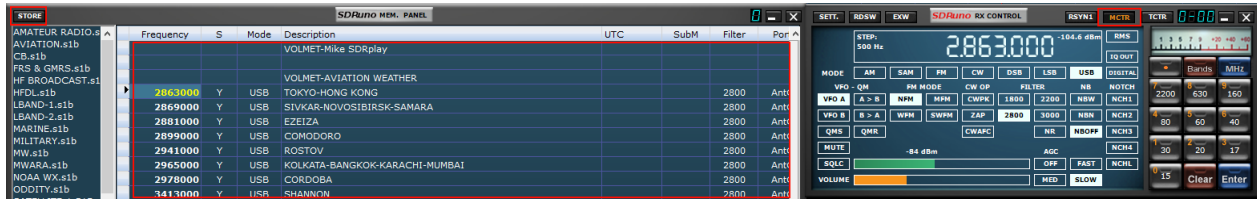

When storing to a new memory location, SDRuno first inserts a new blank row after the current one, filling some fields automatically and finally making that row the current one in preparation for the next operation. The program fills the Frequency, Mode, Submode and Filter fields with data from a specific VRX. There are different methods to perform the above operation:

Storing from a VRX with the **MCTR** button active

- Click on the STORE button on the Memory panel.
- Alternative way: use its keyboard shortcut CTRL+S (the Memory panel must be selected).

Storing from a VRX that has been selected regardless of the MCTR button status

- Use **CTRL+S** (one of the VRX panels must be selected).

12.10 Importing from other database formats



SDRuno can import data from both **EiBi** database files (CSV format) and **Perseus** “Userlist” (*.txt) files. In order to import from a database chose **Import** from the context menu, then select one of the import options. Locate the source file and click Open. The import process takes a couple of seconds (depending on the length of the database and your PC processing power).

The bank created then can be saved as a SDRuno regular bank file.

12.11 Creating a composite bank from several source banks

You can copy-paste from the Memory panel of a given SDRuno instance to another instance; this capability allows complex editing operations like the composition of a bank including data from different “source” banks, without the need of a specialized tool. You only need another Memory panel from a second SDRuno instance. Simply apply all the editing operation already seen but this time using one Memory panel instance as the source and the other as the destination.

12.12 Deleting banks

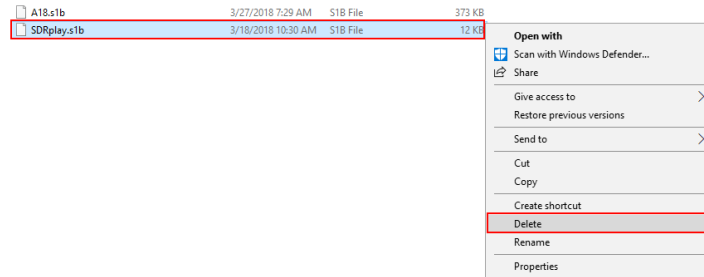

Navigate to the directory assigned for saving SDRuno banks. Delete the bank that is no longer needed.

12.13 Filtering data

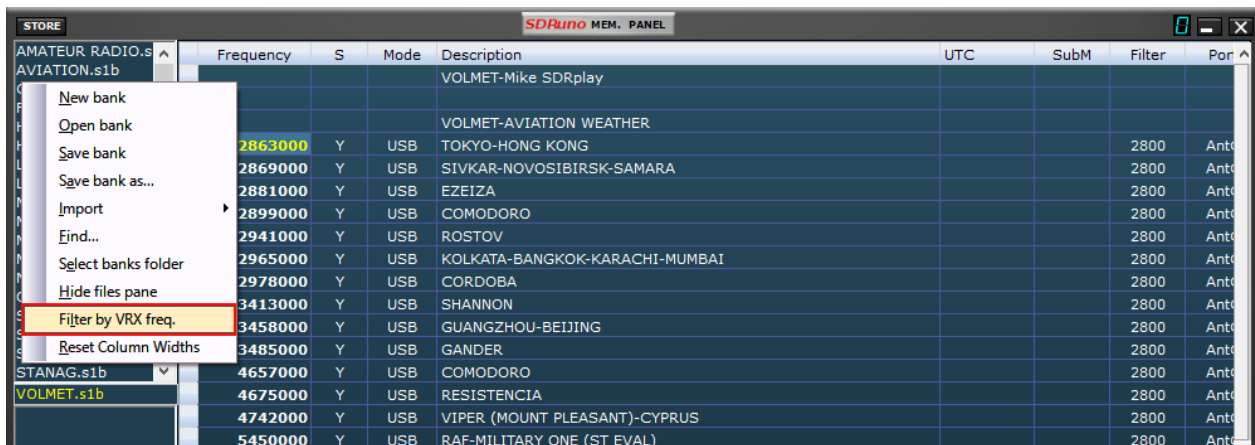

Filtering a data bank means showing only the rows that match filtering criteria. Currently you can only **filter by VRX frequency**. To enable this option, choose Filter by VRX freq. from the context menu. The data grid is updated after every frequency change; since filtering a large data bank is a CPU intensive operation, the program waits until it detects that the tuning operation has ended, and then performs the filtering. If no VRX is assigned to the Memory panel, no filtering occurs. Filtering is disabled when choosing one of the following options:

- New bank
- Import

12.14 Profiles

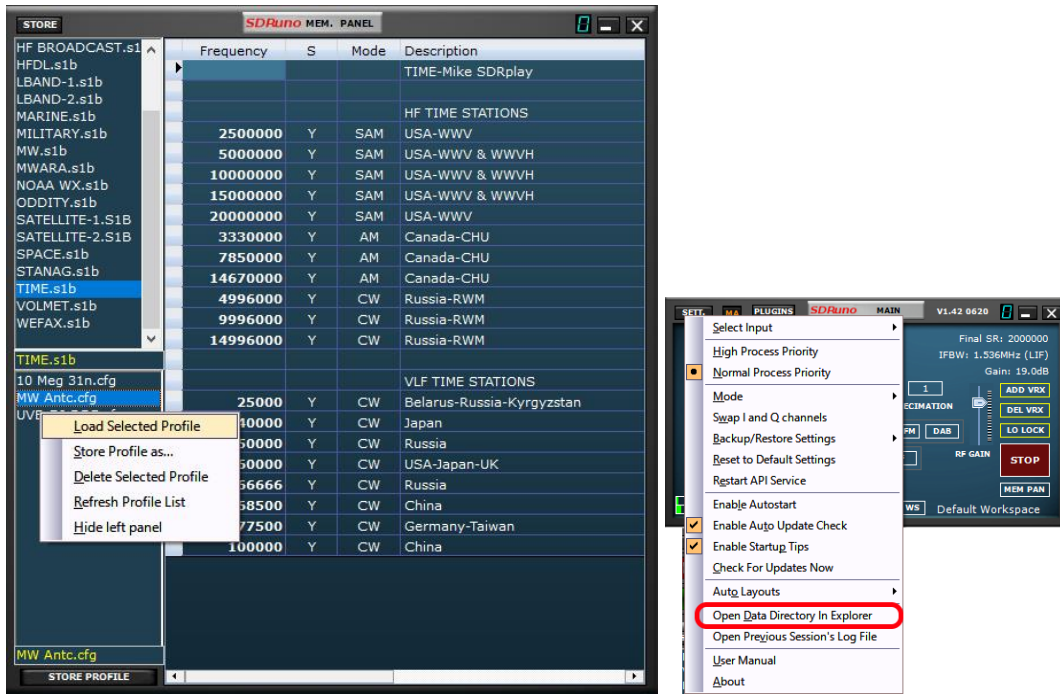

- Load Selected Profile** – Loads the selected profile within the profiles file panel.
- Store Profile as** – Save a new profile.
- Delete Selected Profile** – Deletes the selected profile.
- Refresh Profile List** – Refreshes the file listing within the profiles file panel.
- Hide left panel** – Hides the profile file section from view.
- Store Profile** - Places SDRuno settings into a user created Profile file that can be recalled.
- Right click profile section:** Profile file options

Newly created profiles are stored in the SDRuno data directory. Double clicking a stored profile from the profile file listing will recall the stored profile settings instantly. A profile is a .cfg file that contains the radio settings for a specific RSP and VRX combination in SDRuno. A profile is just the radio configuration and does not contain any panel layout or state information.

Profiles are not a copy of the .ini file and should not get confused as .ini files. Any profile can be recalled into SDRuno as long as the same RSP type and number of VRXs are used that were used when the profile was saved.

Note: When using multiple VRXs, when you recall the profile, you must have a matching number of VRXs open to that saved in the profile. Workspaces are not saved as part of a profile.

13 - IQ Recording



The Recorder panel can be shown by clicking on the “SCHEDULER” button inside the MAIN panel.

Selecting the recording folder

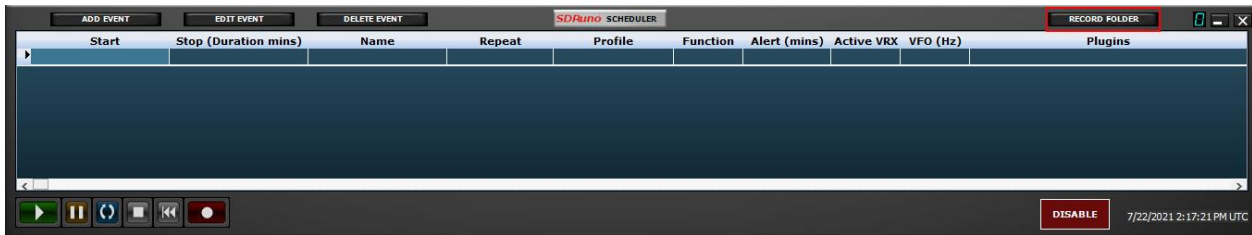

Left click in the “RECORD FOLDER” button: this will pop up the folder selection tree. The default is to use the local system Documents folder.

13.1 Playback of IQ Recording

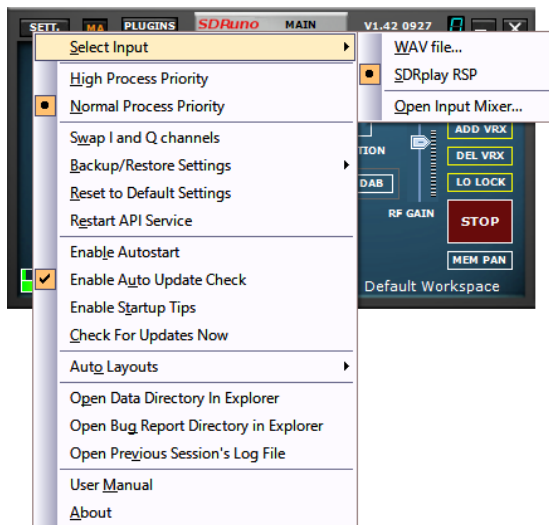

With an RSP connected: Launch SDRUno. Before clicking PLAY on the MAIN panel. Click on the OPT button in the MAIN panel. Select Input and select WAV file. Playback is controlled via the RECORDER panel.

Note: SDRUno can run without an RSP connected: Launch SDRUno. Click “Yes” and locate your IQ wave recording for playback.

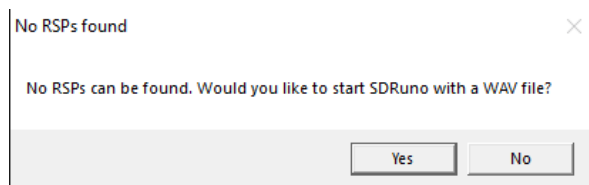

13.2 Quick recording

SDRUno includes a feature to put a SDRUno instance in recording mode “on the fly”, without opening the Scheduler panel. When you wish to start recording simply press ‘*’ on the keyboard (the relative SDRUno instance must be selected).

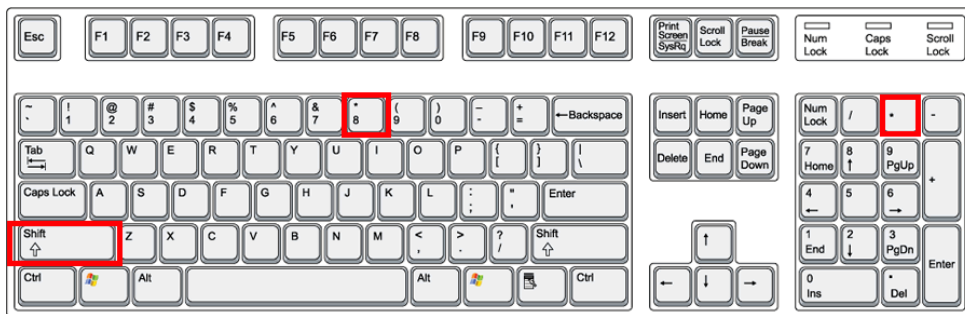

13.3 Using multiple VRX while playing IQ files

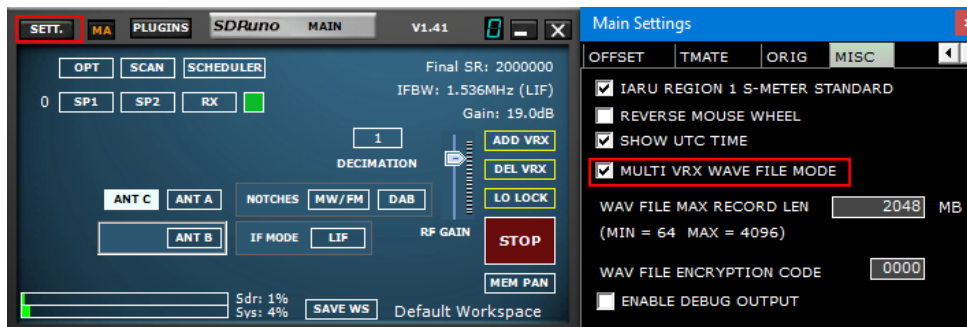

SDRplay allows the use of multiple VRX while playing IQ files. Main panel ->SETT.->MISC->MULTI VRX WAVE FILE MODE. This option is enabled by default; if you wish to use only VRX#0 uncheck the option. IQ Wav files maximum length and custom encoding

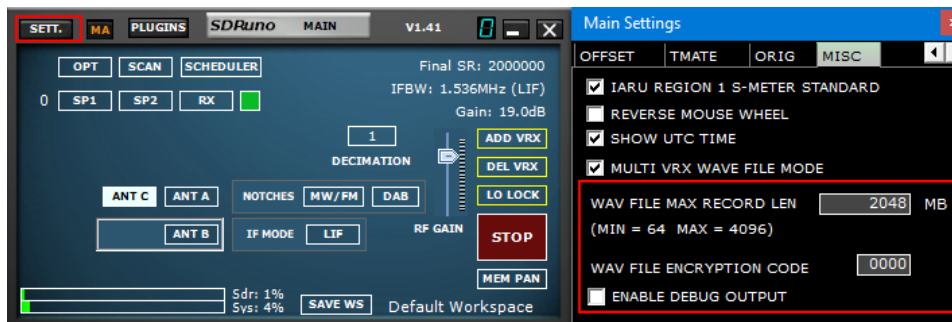

You have an option to define a custom file length up to 4 gigabytes which is the limit of the wav format itself. In fact, in the Wav file header size is stored as a 32-bit unsigned integer so the storable maximum size is 2^{32} bytes. Please note that the advantage of keeping the wav format is compatibility: SDRplay files can be opened with any tools that support that file format. To change the default file size (2048 megabytes) go to Main->SETT.->MISC, double click on the "WAV FILE MAX RECORD LEN" and enter the new size, then press Enter to confirm.

You also have an option allowing a custom encryption code of the recorded IQ file. This code be used to secure the IQ file. This will prevent playback without the proper encryption code entered. The default is 0000 and allows playback without restriction.

13.4 Scheduled IQ recorder

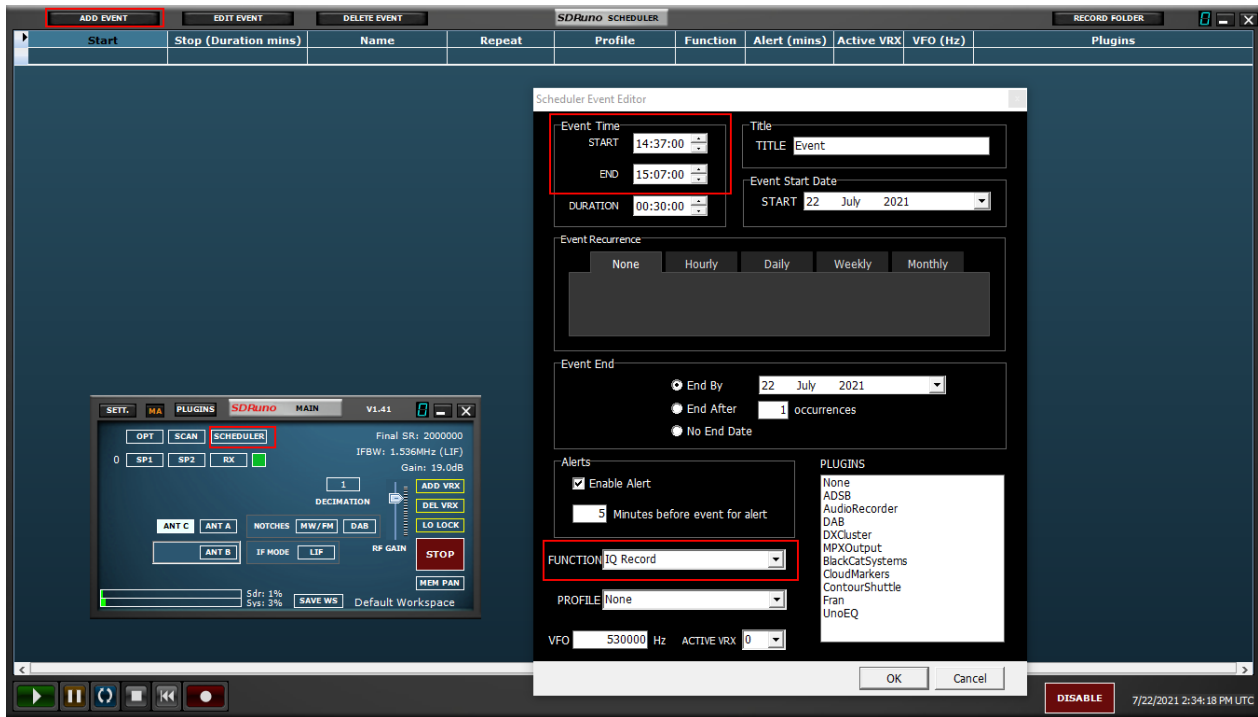

Unattended IQ recording can be configured via the Scheduler button within the MAIN panel. The stream will be started/stopped by the scheduler if it is not already running.

14 - Using the custom controls

SDRuno implements some custom controls specifically created for it.

14.1 Sliders



Sliders are used for some parameters such as audio level, squelch level etc. You have several options to modify a slider value:

- For quick, large changes simply click in the new position of the slider
- For continuous variations click and drag.
- For fine, precise control put the cursor inside the slider and turn the mouse wheel

14.2 Wheel Edit Dials



These controls are easily recognizable as their background turn to purple as you place the cursor above them; some examples are the notch filters BW and Freq. controls in the “RX EX Control” panel . In order to change the value of one of these controls, you must place the cursor inside it, then you have several options (here is an example for a notch Freq. control – actual steps depend upon the specific function):

- Turning the mouse wheel will change the value in +/- 1 Hz steps
- Turning the mouse wheel while pressing the SHIFT key will change the value in +/- 10 Hz steps
- Turning the mouse wheel while pressing the CTRL key will change the value in +/- 0.1 Hz steps
- Right-clicking will change the value in + 100 Hz steps
- Left-clicking will change the value in - 100 Hz steps
- Right-clicking while pressing the SHIFT key will change the value in + 1000 Hz steps
- Left-clicking while pressing the SHIFT key will change the value in - 1000 Hz steps
- Right-clicking while pressing the CTRL key will change nothing (not used in this case)
- Left-clicking while pressing the CTRL key will change nothing (not used in this case)

14.3 The I/O Sample Rate difference issue



Using different physical input and output devices means that there is no synchronization between the I/O sample rates; furthermore, a small deviation (in the order of less of ten to some hundreds of PPM) from the theoretical rates exists. SDR programs (including SDRUno) use memory buffers as “dampers” that absorb those differences; however, sooner or later the buffers will be all filled (overflow) or all empty (underflow), depending upon the sign of the combined input and output deviations. With typical hardware this can happen after several hours of continuous processing. At that point the program will re-establish the correct buffering, trashing some data and creating a small “gap” in the output stream. Of course, there is a way to prevent this, implementing a complex closed loop servo system that monitors the buffering and controls an output fractional resampler. SDRUno can do this, and it works very well, ensuring that no data is lost at any time. However, when the above system is enabled a small frequency modulation of the output signal occurs (in the order of a fraction of Hz when the servo has settled down). In some sensitive applications (APT & other critical signal post-decoding), this small modulation can sometime cause problems; in SDRUno there is an option to disable the output resampler: RX Control ->SETT.->OUT->Lock Output Fractional Resampler. By default, the output fractional resampler is disabled.

14.4 Setting to allow for external front end gain or loss

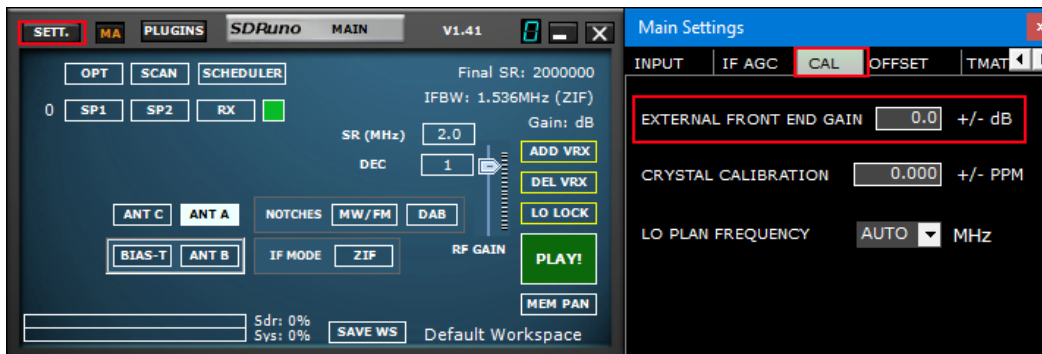

Any additional loss or gain specified here will not affect the calibrated measurements made in SDRUno

15 - External up/down converters offset

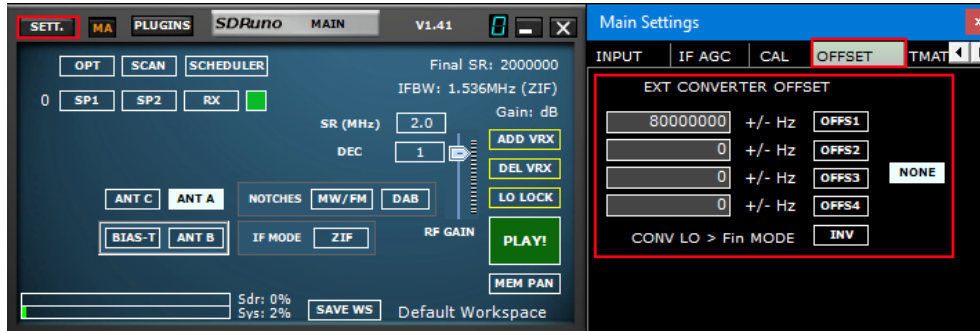

Up to four converter offsets can be stored in each instance of SDRplay. Offset settings are available in Main panel ->Sett.->OFFSET.

15.1 Changing a converter frequency offset

Enter the new frequency in the edit box to the left of the relative button then press the ENTER key.

15.2 Enabling a converter offset

Click the relative offset button.

15.3 Disable any active offset

Click the **NONE** button.

15.4 Inverted spectrum mode

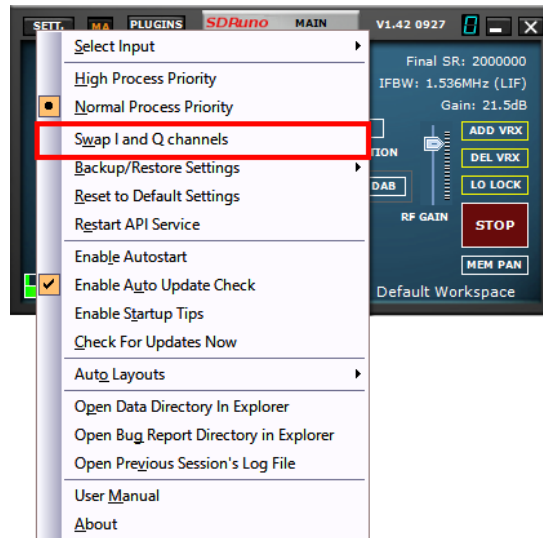

Some converters are designed so that its LO frequency is greater than the input signal frequency; because of this the output spectrum is inverted. In such case the inverted spectrum mode must be activated, clicking the INV button. Also, the I and Q channels must be swapped (Main panel ->OPT->Swap I and Q Channels).

16 - IF Output Mode

The IF output from a transceiver rig can be used as the signal source for the RSP. In this mode the LO frequency needs to be locked to the transceiver's IF frequency, whilst allowing the VFO to be tuned to within the transceiver's limits. Specify the IF output frequency in the settings panel and press the ENABLE button to engage the system. A message is displayed in the SP1 panel to remind you that SDRUno is in this mode.

17 - CAT



CAT control has been around for at least 25 years so it is a well-known technology: there is no need to review the basics here, but a little refresh may be useful to understand how CAT has been implemented in SDRuno.

Whatever CAT protocol we choose, there is always a controlling device and a controlled one. In origin controlling devices were PCs and controlled devices were physical radios (receivers or transceivers) and accessories (rotors, switches, amplifiers etc.). Physical communication ports (serial ports for example) were used for the data exchange.

Per definition, in a CAT session only the controlling device can initiate a transaction. For example, the PC might send a “give me the VFO A frequency” while the radio might reply “the VFO A frequency is 3561230 Hz”. The logical roles can’t be exchanged.

Now that we have software radios (like SDRuno) a CAT session can be no more necessarily only between a program inside a PC and an external device but can be also between different programs inside the same PC (and even in different PCs).

In order to achieve this, we need a way to interconnect programs; one common solution is using special software tools to create “virtual com ports” pairs interconnected with “virtual null modem” cables. Then applications can see the virtual com ports as real ones, using them for communication. More on virtual ports later. Another requirement we need is that the software radio must “impersonate” a controlled device and react the same.

17.1 How SDRuno implements CAT

CAT has been designed in SDRuno so that the application can act as a controlled device and a controlling one at the same time. More precisely, each VRX can be seen as a separate radio on a different com port while at the same time it can control a physical external device via Omnirig.

For CAT radio emulation we chose a sub-set of the extensive Kenwood command set. The following VRX parameters can be set and read:

- VFO A Frequency
- VFO B Frequency
- Active VFO (A – B)
- RX Mode
- AF level
- Squelch level
- S-meter (read only)

Several commands are implemented in a dummy way just to make some controlling programs happy (HRD for example).

SDRuno CAT commands:

SDRuno CAT Control (TS-480 compatible)		The number in the SET/READ/ANSWER represents the parameter position			
Command	Description	SET	READ	ANSWER	PARAMETERS
AC	Reads the internal antenna tuner status		AC;	AC123;	1 = 0 (RX THRU), 2 = 0 (TX THRU), 3 = 0 (Tuning is stopped)
AG	Sets or reads the AF gain	AG1222;	ACG1;	AG1222;	1 = 0 (always 0 for TS-480), 2 = 000 (min) - 255 (max)
AI	Reads the Auto Information (AI) function ON/ OFF		AI;	AI1;	1 = 0 (AI OFF)
AN	Selects the antenna connector ANT1/ ANT2		AN;	AN1;	1 = 1 (Antenna 1)
BC	Sets or reads the Beat Cancellor function status		BC;	BC1;	1 = 0 (OFF)

BY	Reads the busy signal status		BY;	BY12;	1 = 0 (Not busy), 2 = 0 (always 0 for TS-480)
CA	Sets and reads the CW Auto Zero-beat function status		CA;	CA1;	1 = 0 (Not active)
CN	Sets and reads the CTCSS tone number		CN;	CN11;	1 = 0 (actual range is 00 - 41)
CT	Sets and reads the CTCSS function status		CT;	CT1;	1 = 0 (OFF)
DL	Sets and reads the Digital Noise Limiter (DNL) function status		DL;	DL122;	1 = 0 (OFF), 2 = 00 (Level 1)
EX	Sets or reads the Extension Menu		EX111 2234;	EX111223455;	Currently only understands EX0450000; which sends back EX04500000; Menu 045 is filter bandwidth for Data comms and this is set to 0 (OFF)
FA	Reads and sets the VFO A frequency	FA1111111111 1;	FA;	FA11111111111;	1 = Frequency in Hz (11 digits) e.g. 00014195000 is 14.195 MHz. Blank digits must be 0
FB	Reads and sets the VFO B frequency	FB1111111111 1;	FB;	FB11111111111;	1 = Frequency in Hz (11 digits) e.g. 00014195000 is 14.195 MHz. Blank digits must be 0
FN	Sets active VFO (not in TS-480 specification)	FN1;			1 = 0 (VFO A) / 1 = (VFO B)
FR	Selects or reads the VFO or M.CH mode of the receiver	FR1;	FR;	FR1;	1 = 0 (VFO A) / 1 = (VFO B)

FS	Selects or reads the Fine Tuning function status		FS;	FS1;	1 = 0 (OFF)
FT	Selects or reads the VFO or M.CH mode of the transmitter		FT;	FT1;	1 = 0 (VFO A)
FW	Selects or reads the DSP filtering bandwidth		FW;	FW1111;	1 = 0000 (0 Hz) range is 0 to 9999 Hz
GT	Selects or reads the AGC constant status		GT;	GT111;	1 = 002 (Slow)
ID	Reads the transceiver ID number		ID;	ID111;	1 = 020 (TS-480)
IF	Retrieves the transceiver status		IF;	IF111111111111222223333334567789ABCDEEF;	1 = VFO freq (11 digits), 2 = " " (5 spaces), 3 = +0000, 4 = 0, 5 = 0, 6 = 0, 7 = 00, 8 = 0 (RX) / 1 (TX - RFMUTE), 9 = 0 (ISB) / 1 (LSB) / 2 (USB) / 3 (CW) / 4 (FM) / 5 (AM/ECSS) / 8 (DRM), 10 = 0 (VFO A) / 1 (VFO B), 11 = 0, 12 = 0, 13 = 0, 14 = 00, 15 = 0
IS	Sets and reads the IF SHIFT function status		IS;	IS12222;	1 = + (positive shift), 2 = 0000 (range is 0000 to 1100)
KS	Sets and reads the CW electric keyer's keying speed		KS;	KS111;	1 = 010 (range in WPM 010 to 060)
LK	Sets and reads the key lock function status		LK;	LK12;	1 = 0 (Freq lock OFF), 2 = 0 (Tuning control lock OFF)

MD	Recalls or reads the operating mode status	MD1;	MD;	MD1;	1 = 0 (ISB) / 1 (LSB) / 2 (USB) / 3 (CW) / 4 (FM) / 5 (AM/ECSS) / 8 (DRM)
MF	Sets or reads Menu A or B		MF;	MF1;	1 = 0 (Menu A)
MG	Sets or reads the Microphone gain status		MG;	MG111;	1 = 050 (range is 000 to 100)
ML	Sets or reads the TX Monitor function output level		ML;	ML111;	1 = 000 (OFF)
NB	Set or reads the Noise Blanker (NB) function status		NB;	NB1;	1 = 0 (OFF)
NL	Set or reads the NB (Noise Blanker) level		NL;	NL111;	1 = 001 (valid range is 001 to 010)
NR	Sets or reads the Noise Reduction (NR) function status		NR;	NR1;	1 = 0 (OFF)
PA	Sets or reads the pre-amplifier function status		PA;	PA12;	1 = 0 (OFF), 2 = 0 (always for TS-480)
PC	Sets or reads the output power		PC;	PC111;	1 = 020 (range is 005 to either 25, 50, 100 or 200 depending on mode and TS-480 model)
PL	Sets and reads the Speech Processor input/ output level		PL;	PL111222;	1 = 050 (range is 000 to 100), 2 = 050 (range is 000 to 100)
PR	Sets or reads the Speech Processor		PR;	PR1;	1 = 0 (OFF)

	function ON/ OFF				
PS	Sets or reads the Power ON/ OFF status		PS;	PS1;	1 = 1 (ON)
QR	Sets or reads the Quick Memory channel data		QR;	QR12;	1 = 0 (OFF), 2 = 0 (range is 0 to 9 channel number)
RA	Sets or reads the Attenuator function status		RA;	RA1122;	1 = 00 (OFF), 2 = 00 (always 00 for TS-480)
RE	Recording function (not in TS-480 specification)	RE1;	RE;	RE1111;	1 = 0/0000 (stop/stopped) / 1/0001 (start/started) / 4/0004 (pause, resume/pa used, resumed) / 0006 (failure)
RG	Sets or read the RF gain status		RG;	RG111;	1 = 050 (range is 000 to 100)
RL	Sets or reads the Noise Reduction level		RL;	RL11;	1 = 00 (AUTO)
RM	Sets or reads the Meter function		RM;	RM12222;	1 = 1 (SWR), 2 = 0000 (meter value in dots valid range is 0000 - 0010)
RX	Sets the receiver function status	RX;		RX1;	1 = 0 (always 0 for TS-480)
SD	Sets or reads the CW Break-in time delay		SD;	SD1111;	1 = 0000 (FBK - Full Break In) (valid range in ms is 0000 to 1000 in steps of 50)
SH	Sets or reads the DSP filter settings		SH;	SH11;	1 = 00 (1000 or 2500 Hz depending on mode) (valid range is 00 to 13)
SL	Sets or reads the DSP filter settings		SL;	SL11;	1 = 00 (0 or 50 Hz depending on mode) (valid range is 00 to 11)

SM	Reads the S-meter status		SM1;	SM12222;	1 = 0 (always 0 for TS-480), when read = 0, then 2 = 0000 to 0020 (valid meter reading), when read = 1, then 2 = positive dBm result (e.g. 0085 equals -85 dBm)
SQ	Sets and reads the squelch level	SQ1222;	SQ1;	SQ1222;	1 = 0 (always 0 for TS-480), 2 = squelch level (valid range is 000 to 255)
TN	Sets or reads the Tone frequency number		TN;	TN11;	1 = 00 (valid range is 00 to 42)
TO	Sets or reads the Tone function ON/OFF		TO;	TO1;	1 = 0 (OFF)
TS	Sets or reads the TF-SET function status		TS;	TS1;	1 = 0 (OFF)
TX	Sets the transceiver in TX mode	TX1;		TX2;	1 = any (ignored), 2 = 0 (always 0 for TS-480)
VD	Sets or reads the VOX delay time		VD;	VD1111;	1 = 0000 (valid range in ms is 0000 to 3000 in steps of 150)
VG	Sets or reads the VOX GAIN		VG;	VG111;	1 = 000 (valid range is 000 to 009)
VV	Equalizes VFO A and VFO B settings	VV;			VFO A = VFO B
VX	Sets or reads the VOX function status		VX;	VX1;	1 = 0 (OFF)



17.2 VRX CAT parameters

VRX CAT parameters are accessible here: RX Control->SETT.->CAT.

17.3 COM Device

This combo box allows you to select / enter the serial communication device. It is possible to choose among COM1 - COM256 using the drop-down list. If the desired device has a name that it is not listed, enter it directly as follows:

- select the text inside the control (double click on the text)
- enter the device name by the keyboard
- press the Enter key on the keyboard

Default: COM10

17.4 Baud Rate

This combo box allows you to select the speed for the serial device. This setting must match that of the controlling program, the higher the better. It is relevant only if the emulated virtual port has the "emulated baud rate" option enabled, otherwise it can be ignored.

17.5 RX Mode CTRL

This option let you to choose if the controlling program can set the VRX RX mode.

Default: enabled

17.6 Enable & Connect

This option enables CAT and starts the connection to the selected com device. Once enabled, the connection is effective until disabled or until the deletion of the relative VRX; also the connection is performed automatically every time the VRX is created. The status of the connection is indicated by the label placed on the bottom of the panel (STATUS: CONNECTED – NOT CONNECTED). To save system resources, do not enable unused connections.

17.7 Example: connecting to Ham Radio Deluxe

Start creating a pair of virtual com ports named COM10 – COM11; do not select the "emulated baud rate" (you need to do this only once).

Launch SDRuno; assuming we wish to control VRX#0, open the CAT settings of that VRX. COM10 is selected per default; check "ENABLE & CONNECT", the status should change to "CONNECTED". Close the RX Settings panel.

Launch HRD; click on "Connect". The first time you need to create a new radio connection: select "Kenwood" as "Company" and TS-440S (for basic controls) or TS-480 (for additional AF gain, squelch level and S-meter controls) as radio type. Select COM11 as "COM Port" and click "Connect".

Once the connection has started you can try to change frequency, mode etc. In other programs select a generic Kenwood as radio or the above models.

Visit <https://www.sdrplay.com/docs/HRDandSDRuno.pdf> for additional information.

18 - SDRuno as the controlling device – Omnirig



SDRuno can control other devices (via CAT) thru the Omnirig COM server, a brilliant utility developed by Alex Shovkopyas, VE3NEA of Afreet Software, Inc. The main purpose (and advantage) of Omnirig is to provide a common “transparent” interface to applications; the controlling application doesn’t have to deal with a specific radio but instead sends and receives commands to Omnirig that in turn acts as a “bridge”. Omnirig can be “instructed” to work with a specific radio by “rig description” files that are relatively simple to create. There is already a huge list of supported devices and others can be added when needed, without the need to modify the code of neither Omnirig nor the application using it. In the past, Omnirig has become a standard and a huge list of applications relies on it: it is freeware, reliable and easy to install and set-up. For details please see the Omnirig web site <http://dxatlas.com>

18.1 Omnirig installation and set-up

You may already know about Omnirig and you may have already installed it on your system: if not please download Omnirig from <http://www.dxatlas.com/omnirig/> . Installation is straight-forward: just launch the installer and follow the instructions. Omnirig can control up to two devices at once (and so SDRuno, see below), RIG1 and RIG2; both must be configured in the Omnirig control panel. If your rig is not listed among the available rig types, do a search on the web for a suitable rig description file, then add it to the “Rig” folder, located inside the Omnirig installation folder. Some setup tips: for best responsiveness use the higher baud rate your rig supports and set the polling interval to 100 mS. Please note that Omnirig can also see non-physical devices thru virtual COM ports (other applications for example).

18.2 How SDRuno handles Omnirig

As you know SDRuno is a multi-instance environment; for better control and efficiency SDRuno filters all the traffic from/to its VRX(s) to/from Omnirig thru an internal own “server”. The latter is created in the SDRuno instance #0. Omnirig can control up to two devices at once; at a given time only one VRX, of whatever SDRuno instance is allowed to connect to an Omnirig device (RIG1 or RIG2); a mutual exclusion logic prevents overlaps. In short, up to two VRX can connect to Omnirig at the same time, one per device.

18.3 Monitoring Omnirig status from SDRuno instance #0

A monitoring feature is available from SDRuno instance #0; go to Main->SETT->ORIG. Look at the bottom label first: this is the status of the connection to Omnirig; if Omnirig is correctly installed the label must show "Connected to OmniRig server". If there are problems "Can't connect to the OmniRig server" is shown instead: if this is the case recheck Omnirig installation. For each Omnirig device, additional information is shown (only RIG1 is described, the same applies for RIG2):

RIG1 Type:

Shows the RIG1 device type currently configured in Omnirig.

RIG1 Status:

Shows the RIG1 status reported by Omnirig; if there is an active working connection, the status is "On Line". Other statuses include "Rig is not responding" and "Rig is not configured".

RIG1 Used By:

Shows which SDRuno VRX is currently connected to RIG1 (instance # and VRX #).

18.4 Which parameters are synchronized?

The following parameters are sent/received from SDRuno to/from the controlled device:

Omnirig	SDRuno	Note
VFO A frequency	VFO A frequency	If the controlling device has only one VFO, VFO A is used
VFO B frequency	VFO B frequency	
VFO selection	VFO selection A - B	
Modulation mode	Modulation mode	Optional
RX-TX status	RX-TX status	Mute the VRX in TX, see below

Note: if the controlled device is a transceiver or transmitter, putting it in TX mode causes the VRX to enter a special mode: a yellow label "RF MUTE" shows up in the RX Control panel, the MUTE button (AF muting) is activated and a 60 dB attenuation is applied to the signal after the SP1 display (so that real input levels are still shown) to facilitate AGC recovery. As the device exits TX mode the VRX returns to normal mode. you can use the key shortcut "T" to toggle the RX-TX modes of a synchronized transceiver/transmitter (provided that the "SYNC VRX -> RIG" option is enabled, see below); this feature can be useful also if there isn't a synchronized device as it also toggles the RF MUTE status in the relevant VRX.

18.5 Omnirig related VRX options

Several options control the VRX/Omnirig connection; they are VRX parameters and must be set on a VRX basis. To access these parameters, go to RX Control->SETT->ORIG.

18.6 RIG Selection

These buttons select the target device, RIG1 or RIG2. This setting also changes the name of the RSYN button on the RX Control panel to reflect the selection (RSYN1 or RSYN2).

Default: RIG1.



18.7 SYNC VRX->RIG

If checked, the controlled device is synchronized to the VRX.
Default: checked.

18.8 SYNC RIG->VRX

If checked, the VRX is synchronized to the controlled device (the VRX reflect changes made on the controlled device). You must enable this option to use the muting on TX feature.
Default: unchecked.

18.9 SYNC Centre FREQ. (LO)

If checked, the frequency information is relative to the VRX "centre frequency" (the SDR hardware local oscillator). You must enable this option if the controlled device is also the front-end of the receiving chain that includes SDRuno.
Default: unchecked.

18.10 SYNC RX Mode

If checked, the modulation mode is also synchronized.
Default: checked.

18.11 The RSYN button

The RSYN button on the RX Control panel activates the synchronization of the relative VRX with the selected Omnirig device. A mutual exclusion logic avoids multiple VRX accessing the same device at the same time. The status of this button is persistent between sessions.

19 - Tmate and Tmate 2 Controllers

SDRuno natively supports the Tmate and Tmate 2 controllers. SDRuno makes full use of the controllers in the “multi instance” environment: this has been achieved by implementing a “Tmate server” and using inter-process communication (IPC).

What do I need to use Tmate (and Tmate 2) with SDRuno?

First you need to connect the Tmate to a free USB port. For Tmate you need also to install its driver while for Tmate 2 this is not necessary (Tmate 2 is a HID device so it uses a system standard driver. The following files (supplied with SDRuno) must be included in your SDRuno folder(s):

- For Tmate: ELAD_Encoder.dll.
- For Tmate 2: Tmate2_DLL.dll.

19.1 The Tmate server

The Tmate server implements bi-directional communication between the Tmate and whatever VRX you like, even across multiple application instances (more on this later). Think of the Tmate server as a “global resource”; it is created (if needed) by the SDRuno instance #0. The process is of course entirely transparent to you.

19.2 Tmate server options



The Tmate server options are accessible only from the SDRuno instance #0 from here: Main panel ->SETT.->Tmate.

19.3 Enable Server

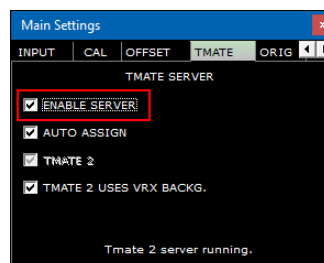

This checkbox enable/disable the Tmate server; the server status is reported on the bottom: once enabled, if everything is ok you should read “Tmate server running.”. If the program reports an error, first check that no other application has allocated the Tmate (remember, Tmate is “single client”).

Default: disabled

19.4 Auto Assign

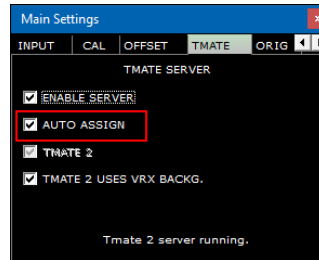

This checkbox let you choose between two “assigning” options for the Tmate controller.

If AUTO ASSIGN is checked, the VRX controlled by the Tmate is the one that currently has one of its **SP1**, **SP2**, **RX Control** or **RX EX Control** panel selected (the “SDRuno” label in the panel is red). This is the simplest and fastest way to assign the Tmate controls to a VRX.

If AUTO ASSIGN is unchecked, you have to assign the Tmate to a specific VRX by the “TCTR” button located on the upper-right border of the relative RX Control panel. To avoid confusion, a mutual exclusion logic is implemented: only one VRX can be assigned at a given time.

Default: enabled

19.5 Tmate 2

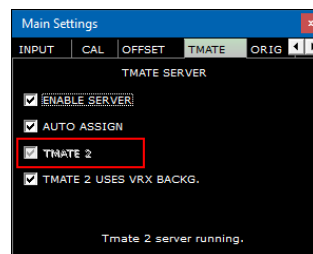

This checkbox let you choose between the two Tmate models. You can have both a Tmate and a Tmate 2 controllers connected to the system at the same time. In order to change this setting, the Tmate server must be stopped (uncheck ENABLE SERVER).

Default: disabled (controller type is Tmate)

19.6 Tmate 2 Uses the VRX background

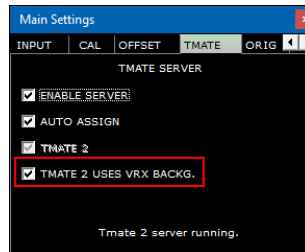

The Tmate 2 controller features an LCD display with a RGB backlit. This checkbox lets you choose between two backlighting modes:



If checked, the LCD backlighting colour follows the assigned VRX background colour.
 If unchecked, the LCD backlighting is set to a fixed neutral colour.
 Default: enabled

19.7 Tmate Controller



Currently the Tmate controls are implemented as follows:

Tuning Knob

Tmate employs a 128 steps/turn optical encoder. Each step corresponds to a given increment/decrement of the VRX tuning frequency and it is the same used for the mouse wheel (see 2.7 – 2.8). The current tuning step is shown in the RX Control panel to the left of the frequency dial. When the spinning speed exceeds a certain threshold, a multiplying factor of 5X is applied to the current step; this feature is quite common in traditional (hardware) receivers and transceivers. The knob can be locked (see below).

F1-Decrease Step

Decreases the tuning step to the next lower value (if available).

F2-Increase Step

Increases the tuning step to the next higher value (if available).

F3-Knob Lock

Locks/unlocks the tuning knob; the locking status is indicated in the RX Control panel, to the left of the frequency dial.

F4-Mute

This button has the same effect of the MUTE button inside the RX Control panel. Please note that the tuning step, lock and mute options are independent for each VRX.

19.8 Tmate-2 Controller



Currently the Tmate 2 controls are implemented as follows:

Tuning Knob.

Tmate employs a 32 steps/turn encoder. Each step corresponds to a given increment/decrement of the VRX tuning frequency and it is the same used for the mouse wheel. The current tuning step is shown in the RX Control panel to the left of the frequency dial and also in the Tmate 2 display. When the spinning speed exceeds a certain threshold, a multiplying factor of 5X is applied to the current step; this feature is quite common in traditional (hardware) receivers and transceivers. A further increment in speed triggers a 10X multiplying factor. The knob can be locked (see below). Pushing the tuning knob will perform a LO LOCK (MAIN panel).

E1 Encoder.

The function of this control can be selected by you: pushing the knob and selecting the current function among the five available:

- VOL adjust the VRX audio level (AF level or volume).
- RFG adjust the AGC gain (if AGC is enabled) or the RF gain (if AGC is disabled).
- SQL adjust the squelch threshold.
- NR adjust the amount of Noise Reduction
- NB adjust the threshold of the Noise Blanker

E2 Encoder.

The function of this control can be selected by you: pushing the knob and selecting the current function among the two available:

- HIGH adjust the selectivity filter high frequency limit.



- LOW adjust the selectivity filter low frequency limit.

F1 – Decrease Step.

Decreases the tuning step to the next lower value (if available).

F2 – Increase Step.

Increases the tuning step to the next higher value (if available).

F3 – Knob Lock

Locks/unlocks the tuning knob; the locking status is indicated in the RX Control panel, to the left of the frequency dial and by the LOCK LED on the Tmate 2 window.

F4 – Assignable Button

The function of this button depends upon the current parameter controlled by the E1 encoder:

- VOL MUTE on/off.
- RFG AGC on/off.
- SQL squelch on/off.
- NR Noise Reduction on/off.
- NB Noise Blanker on/off (NBW only).

F5 – RX Mode

Selects the current receiving mode.

F6 – VRX Selection

Assigns the Tmate to the next VRX of the same instance.

LED & LCD display

USB LED

This LED is lit when there is connection with the Tmate server.

Lock LED

This LED will illuminate when the tuning knob is locked (see F3 button).

LCD Display

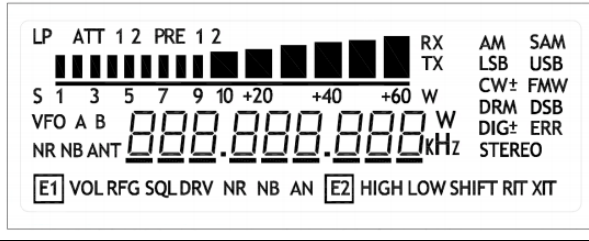

The Tmate 2 display shows many VRX parameters; the tuning frequency field also doubles as parameter value indicator. When the frequency exceeds the 9 digits capability of the display, the entire field is shifted one digit to the right (10 Hz resolution).

20 - Abbreviations and Acronyms

AFC	Automatic Frequency Control
AGC	Automatic Gain Control
AM	Amplitude Modulation
A/D	Analog to digital
ADC	Analog to digital converter or analog to digital conversion
AF	Audio frequency
ANF	Automatic notch filter
CAT	Computer aided transceiver
CPU	Central processing Unit
CSV	Comma Separated Value
CW	Continuous wave
D/A	Digital to analog
DAB	Digital audio broadcasting
DAC	Digital to analog converter or digital to analog conversion
dB	Decibel a way of representing numbers in a logarithmic scale
dBm	dB relative to 1mW of power
dBFS	Signal level compared to the ADC full-scale level, expressed in dB
DLL	Dynamic link library
DRM	Digital radio mondiale
DSB	Double side band
DSP	Digital signal processing
FFT	Fast Fourier Transform
FM	Frequency modulation
GHz	Gigahertz
GUI	Graphical user interface
HDR	High Dynamic Range
HF	High Frequency
Hz	Hertz
IF	Intermediate frequency
IQ	Refers to the In-phase & Quadrature data which is the baseband cartesian representation of the signal
kHz	Kilohertz
LF	Low Frequency
LFER	Low Frequency experimental radio
LIF	Low-IF. An intermediate frequency that is less than the carrier frequency
LNA	Low noise amplifier
LO	Local Oscillator - the frequency that the SDR synthesizer is tuned to.
LSB	Lower sideband transmission
LW	Long Wave
MFM	Medium bandwidth Frequency Modulation
MHz	Megahertz
MW	Medium Wave
NDB	Non-directional beacon
NDBH	Non-directional beacon (Higher band)



NDBL	Non-directional beacon (Lower band)
NFM	Narrowband Frequency Modulation
NR	Noise Reduction
Panadapter	A spectrum display of a section of spectrum
PPM	Parts per million
PWR	Power
QAM	Quadrature amplitude modulation
QPSK	Quadrature phase-shift keying
RBW	Resolution bandwidth
RDS	Radio data system
RSP	Radio spectrum processor
SAM	Synchronous amplitude modulation
SNR	Signal-to-Noise Ratio in dB
UHF	Ultra high frequency
USB	Universal serial bus
USB	Upper sideband transmission
VHF	Very high frequency
VFO	Variable Frequency Oscillator - the frequency that SDRuno is tuned to
VRX	Virtual receiver
VLf	Very low frequency
WFM	Wide Frequency Modulation
ZIF	Zero-IF. IF signal represented in its in-phase and quadrature components

21 - Appendix 1 Using the RSPduo with SDRuno.

RSPduo overview.

The RSPduo is a radical new product from SDRplay. Architecturally, it is different from any previous RSP in that it features dual independent tuners, both piped through a single USB 2.0 interface. Superficially the RSPduo will look virtually identical to the RSP2pro and will be able to operate in a very similar way, but it also allows a completely new and unique set of usage scenarios.

The Basic block diagram of the RSPduo is:

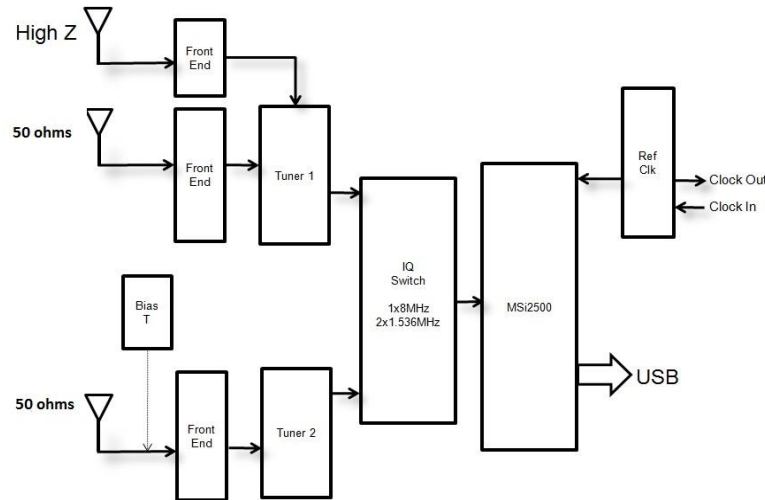

The MSi2500 contains dual ADCs. This allows the sampling of I/Q analog baseband signals when the tuner is used in Zero IF mode. However, the tuner can also operate in a Low IF mode, where a single ADC is used to sample the output from the tuner. This opens up the possibility of having two independent tuners operating simultaneously, but this is **ONLY POSSIBLE IF BOTH TUNERS ARE OPERATING IN LOW IF MODE**. In Low IF mode, the maximum flat pass-band bandwidth of the IF filters in the tuner is 1.536 MHz, whereas in ZIF mode, it is possible to widen these filters to 8 MHz.

This is the approach used in the RSPduo. The receiver can either operate each tuner individually (one at a time) in zero IF mode with a displayed bandwidth up to 10 MHz or both tuners simultaneously with a maximum displayed bandwidth of 2 MHz.

The simultaneous use of two independent tuners (albeit with reduced bandwidth) makes certain key usage scenarios possible:

1. Simultaneous monitoring of two widely spaced bands – e.g. 40m and 2m
2. Mixing and matching applications simultaneously – e.g. ADS-B and ATC scanning
3. Phase and time coherent demodulation of two receivers

Scenario 3 is very difficult to achieve with two separate USB devices because of the uncertainty of USB latency. So whilst it is possible to phase lock the clocks of multiple RSP2s, the uncertainty of USB latency



meant that the timing of the two units would not be aligned when it came to demodulation. The only way to overcome this was to apply timing correlation in software which requires a ‘training sequence’ to be simultaneously applied to both devices. The RSPduo overcomes this limitation because all traffic goes through a single USB interface.

Operating with two tuners simultaneously – The Master/Slave Concept

Whilst the tuners can be controlled completely independently in terms of gain and frequency, there is one common factor that cannot (indeed should not) be separated and that is the ADC sample rate.

Because of this, whichever tuner is set up first will dictate the sample rate of the second receive path. To make it clear, we designate the first receiver to be set up as the ‘Master’ and the second one the ‘Slave’.

A Windows Service based API for Device Management

From SDRuno release 1.23, a new way of managing RSP devices has been introduced. This is a requirement for handling the two tuners in the RSPduo.

Instead of the API either being embedded within the application (such as with SDRuno) or a separate DLL (as with HSDR and SDR Console), it is necessary to operate the API as a background ‘service’ within Windows. The service constantly monitors what is available in terms of receiver hardware and communicates this to the application at start-up. This way, it is possible to avoid the application attempting to configure a tuner on start-up into a mode that is simply not possible because another tuner is already designated as the ‘Master’ by a different application.

The matrix of available hardware options (for a single RSPduo) to the various applications will be as follows:

Operating mode	Tuner 1 Available RF ports	Tuner 2 Available RF ports	Master sample rate	Slave Sample rate	Tuner 1 IF Bandwidth	Tuner 2 IF Bandwidth	Tuner 1 frequency range	Tuner 2 frequency range
Single receiver (Tuner 1)	50 Ω/Hi-Z	Not available	2-10 MHz	N/A	200 kHz – 8 MHz	N/A	1 kHz – 2 GHz	N/A
Single receiver (Tuner 2)	Not available	50 Ω with Bias T	2-10 MHz	N/A	N/A	200 kHz – 8 MHz	N/A	1 kHz – 2 GHz
Dual tuner (tuner 1 master)	50 Ω /Hi-Z	50 Ω with Bias T	6/8 MHz*	Determined by Tuner 1	200 kHz – 1.536 MHz	200 kHz – 1.536 MHz	1 kHz – 2 GHz	1 kHz – 2 GHz
Dual tuner (tuner 2 master)	50 Ω /Hi-Z	50 Ω with Bias T	6/8 MHz*	Determined by Tuner 2	200 kHz – 1.536 MHz	200 kHz – 1.536 MHz	1 kHz – 2 GHz	1 kHz – 2 GHz

*In low IF mode, there will only be two sample rates available:

1. 6 MHz – This is designated “Normal Mode” when operating in dual tuner mode in SDRuno. In this mode, the ADC resolution is 14 bits.
2. 8 MHz – This is designated either “ADS-B Compatible Mode” or “DAB Compatible Mode” when operating in dual tuner mode in SDRuno. This master mode is required for compatibility for running either ADS-B or DAB applications or plugins on the slave tuner. In this mode, the ADC resolution is 12 bits.

Operating the RSPduo with SDRuno (release 1.3 and onwards)

When first starting SDRuno when using the RSPduo application will auto configure the various panels to fill the screen in the most efficient manner possible.

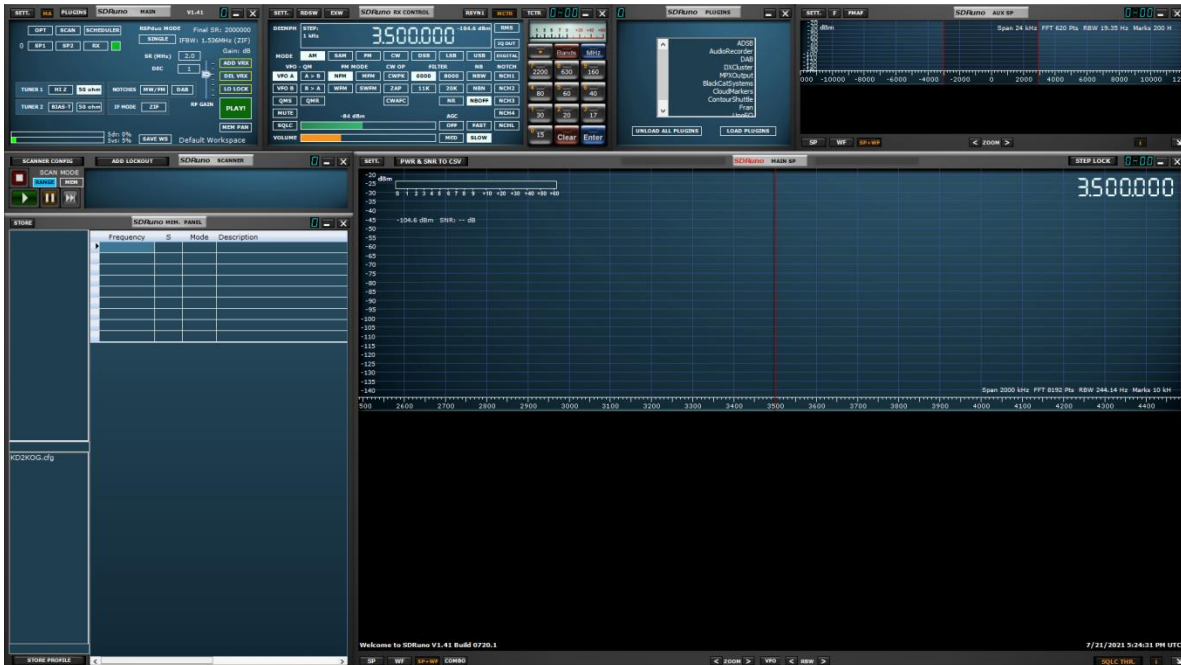

The Memory Panel

When saving to a memory bank with the RSPduo the displayed Antenna source (Port) in the memory bank will be as follows:

Tuner 1 Hi-Z	Hi-Z
Tuner 1 50 Ohm	Ant A
Tuner 2 50 Ohm	Ant B

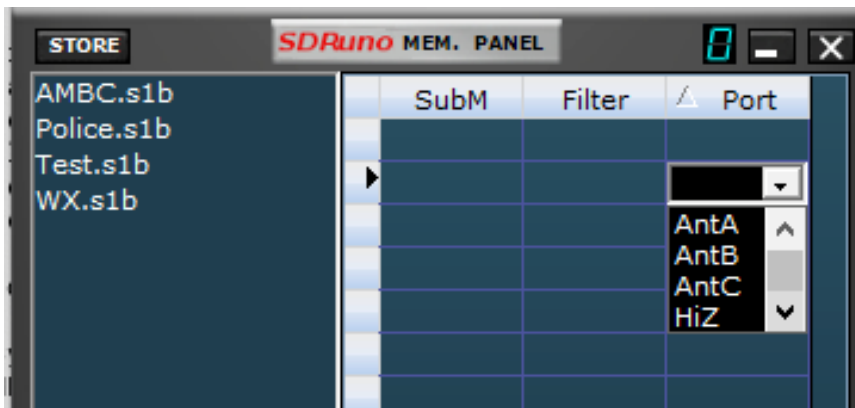

When recalling from the memory bank the same assignments apply with one addition: if Ant C is displayed in the memory bank (e.g. if the entry was created manually or with an RSPdx) it will select Tuner 1 Hi-Z in the RSPduo.

The Main Panel

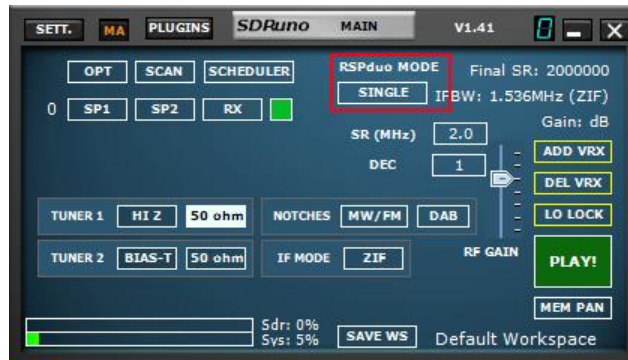

When using the RSPduo, the Main Panel will indicate the operating mode of the device.

As long as no other application (e.g. ADS-B) is already using one of the tuners within the RSPduo, upon start-up, SDRuno will always initially configure the device in “Single” tuner mode. In Single Tuner Mode, either tuner can be operated individually but not both tuners simultaneously. In Single Tuner Mode, each tuner can be configured in Zero IF (ZIF) mode or in low IF (LIF) mode.

Selecting either the Hi-Z port or the 50 ohm port associated with Tuner 1 will automatically configure Tuner 1 for use. Selecting the 50 ohm port associated with Tuner 2 will automatically configure Tuner 2 for use. In Single Tuner Mode, the RSPduo will operate in a very similar way to the RSP2/RSP2pro.

Dual Tuner operation (simultaneous operation of both tuners)

When switching to Dual Tuner, firstly determine which tuner you wish to be designated as the ‘Master Tuner’ and select one of the antenna ports for this tuner. Then select the RSPduo Mode button and two options will appear:



DUAL (NORMAL) - Select this mode unless you intend to run ADS-B using the Slave Tuner

DUAL (ADS-B) – This is ADS-B Compatibility Mode and is required if you intend to run ADS-B (dump1090) using the Slave Tuner. If you plan to use this mode, ensure that Tuner 1 has been selected BEFORE selecting this mode. This is because ADS-B (dump1090) uses Tuner 2 by default.

DUAL (DAB) – This is DAB Compatibility Mode and is required if you intend to run DAB plugin using the Slave Tuner. If you plan to use this mode, ensure that Tuner 1 has been selected BEFORE selecting this mode. This is because DAB uses Tuner 2 by default.

After selecting one of these three options the selected tuner will be the 'Master Tuner' and DUAL (M) will be the indicated RSPduo Mode:

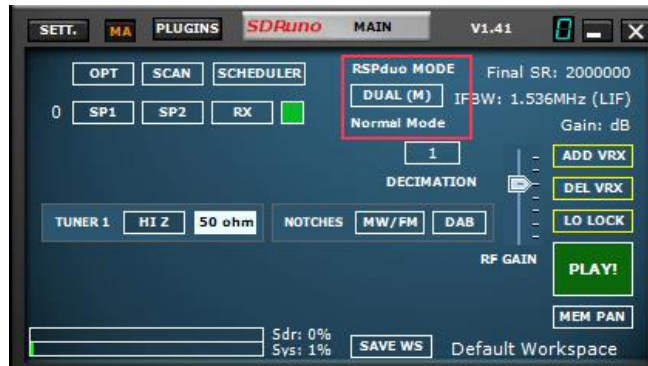

If you intend to run both tuners with SDRUno using a single monitor, you can select the Auto Layout feature from the Options Panel:

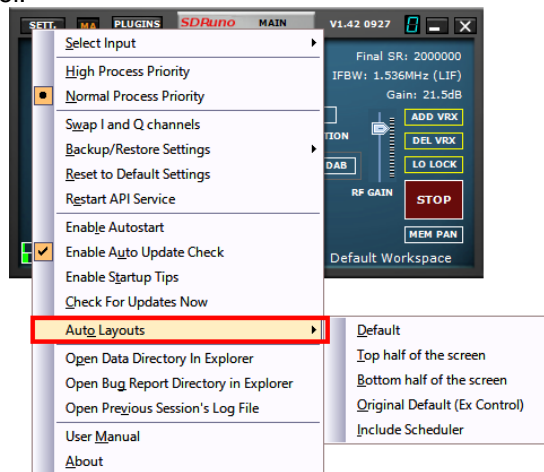

If you select the RSPduo Master option, the panels will be re-configured to fill the top half of the screen in an optimal way:

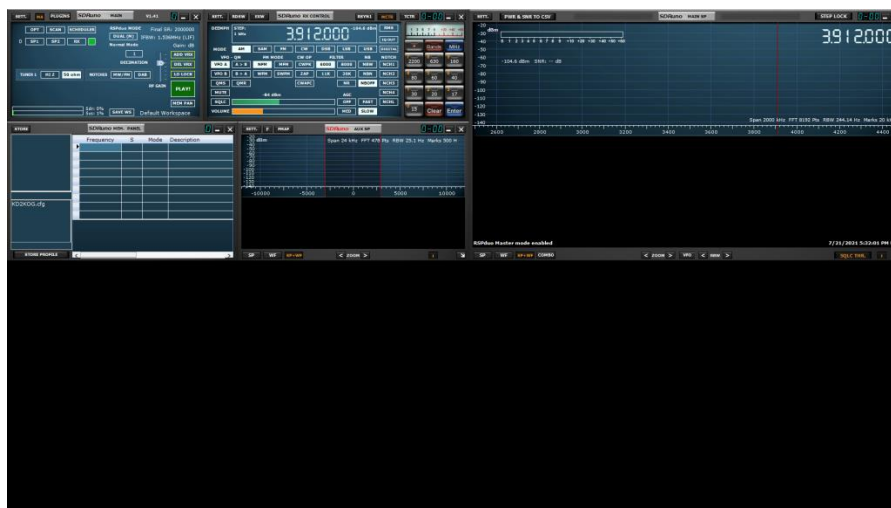

If you select the RSPduo Slave option, the panels will be re-configured to fill the lower half of the screen in an optimal way:

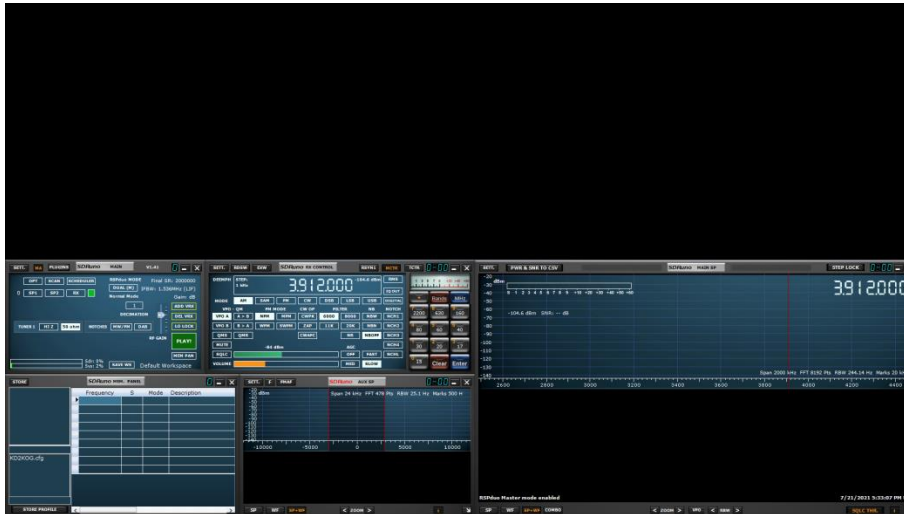

Either of these workspaces can then be saved so that they will open by default.

Having designated one of the tuners as the Master Tuner, to use the second tuner at the same time, it is now necessary to start a second instance of SDRuno.

This second instance of SDRuno will automatically recognise that the second tuner is operating in 'Slave mode' and the Main Panel RSPduo Mode will indicate DUAL (S):



Using the Auto Layout Feature (OPT button), it is now possible to have both instances of SDRuno fill the screen in an optimum way:

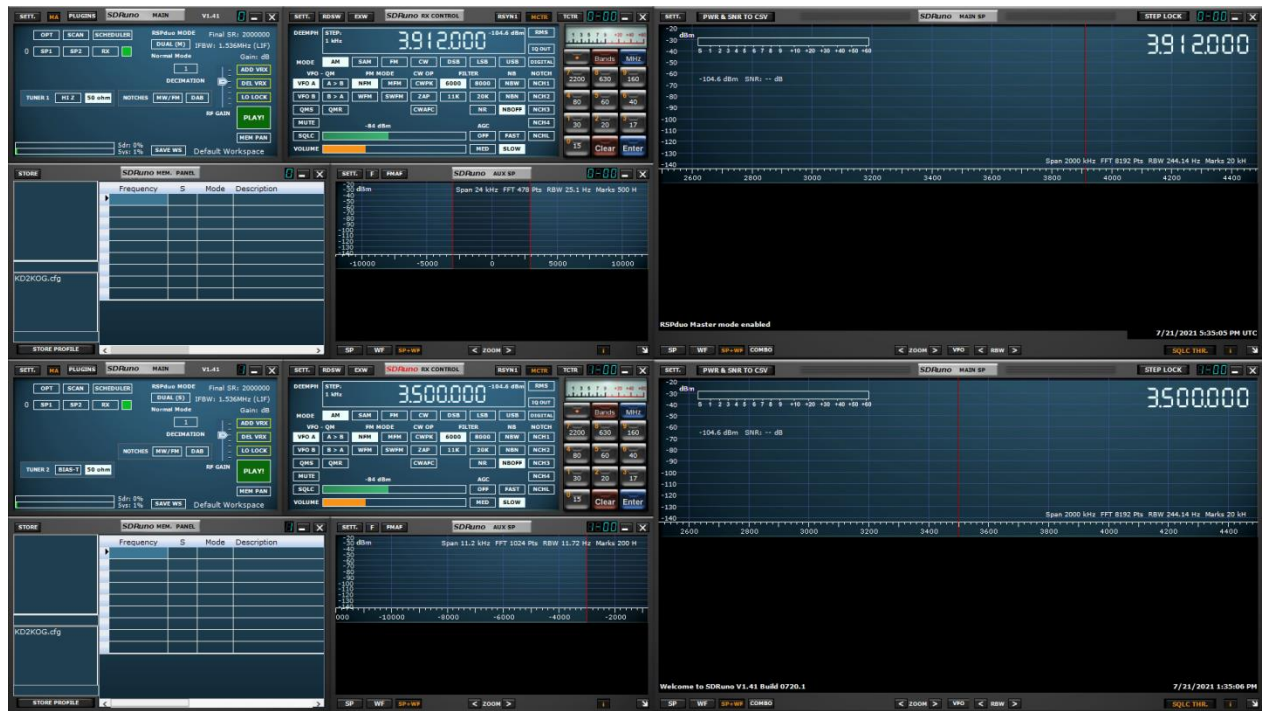

Before starting the stream for the Slave Tuner, it is first necessary to start the stream for the Master Tuner. If you attempt to start the Slave Tuner before first starting the Master Tuner, you will receive the following error message:

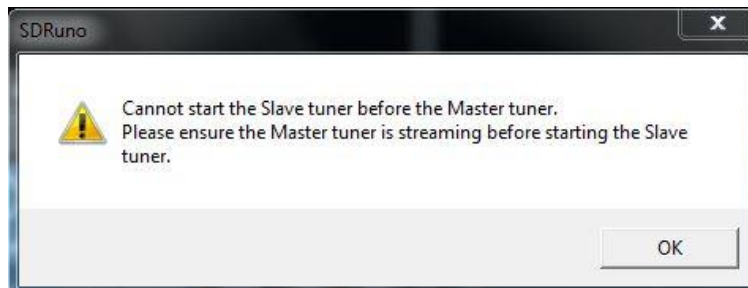

Having started the Slave Tuner via a second instance of SDRuno, if you attempt to close the instance of SDRuno that is running the Master Tuner, you will see the following message:

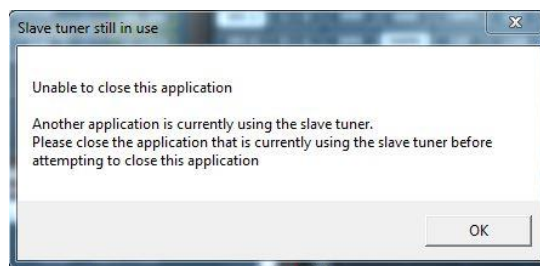

The Master can only be closed after the Slave has been closed. If a different application (e.g. ADS-B) is already using one tuner in Master Tuner mode, SDRuno will automatically open the remaining tuner as the Slave.

Memory Panel

When saving to a memory bank the antenna labelling is the same as described previously:

Tuner 1 Hi-Z - Hi-Z / Tuner 1 50 Ohm - Ant A / Tuner 2 50 Ohm - Ant B

The behaviour when recalling from the memory bank depends on the which Tuner is showing in the SDRuno Main window:



Tuner 1

RSPduo Input selected
Tuner 1 Hi-Z
Tuner 1 50 Ohm

Memory Panel Port
Hi-Z, Ant C
Ant A, Ant B



Tuner 2

RSPduo Input selected
Tuner 2 50 Ohm

Memory Panel Port
Any

Viewing more than 2 MHz of Spectrum (Single Tuner, ZIF mode only)



When the RSPduo is operating in Dual Tuner mode (Master or Slave), it will ONLY operate in Low IF mode with a maximum viewable bandwidth of 2 MHz. If you wish to have a viewable bandwidth of greater than 2 MHz, then it will be necessary to close the Slave Application and switch SDRUno back to Single Tuner Mode using the RSPduo Mode button on the Main Panel. After switching from Dual Tuner Mode back to Single Tuner mode, the device will still be in Low IF mode, so it will be now necessary to switch to Zero IF Mode via the Setting Panel:

The Main Panel should now show that the device is operating in ZIF (Zero IF) mode and the amount of viewable spectrum can be changed by selecting a different sample rate:



Diversity

From V1.32 onwards, MRC (Maximal Ratio Combining) Diversity is supported using the RSPduo. MRC Diversity can be used to combine the 2 tuner input streams together to potentially improved the SNR (signal to noise ratio). The same frequency is used for both tuners in the RSPduo and the gain can be adjusted either on each tuner independently or locked together (the default method).



Diversity mode is enabled by clicking on the RSPduo MODE dropdown and select DIVERSITY. Make sure both the 50 ohm ports are connected to the correct input source and note that the HiZ port is not available for Diversity mode. Trying to use the HiZ port will result in an error message being displayed.

Once diversity mode is enabled, the diversity controller window will appear (shown below). This window shows the current phase and amplitude being applied and the automatic values that are being continuously calculated and applied (if the APPLY AUTO button is pressed, which is the default mode). The automatic values have A preceding them in the display.



The automatic mode can be disabled by pressing the APPLY AUTO button and then with the left mouse button pressed down, select a phase (indicated by the angle in the circle) and an amplitude (indicated by the length of the line to be applied to the incoming IQ streams). The phase and amplitude controls can also be independently locked so as to allow finer manual control.

The result of the combination is sent to the rest of SDRuno as a single IQ stream and so all the post processing within SDRuno is still fully functional.

22 - Appendix 2 RSPdx's HDR mode usage

Overview

The RSPdx has an HDR (High Dynamic Range) mode when operating below 2 MHz – SDRuno always uses HDR mode whenever a RSPdx is in use and the framed band of interest is lower than 2 MHz. It's important to remember that HDR mode is **ONLY** available using the RSPdx. HDR mode is **ONLY** selected when using one of the framed bands below 2 MHz

Usage

Starting with version 1.33 of SDRuno, the only way to engage HDR mode is through the band buttons in the RX Control Panel.



The above image shows the HDR bands in the keypad on the right-hand side.

In addition to these, HDR mode is also used, remember for the RSPdx only, when 2200, 630, 160, LW or MW are used in the other band groups.

When a HDR framed band is selected, HDR mode will be indicated in the IFBW field at the top right corner of the Main Panel.

If the green "ON" light is lit on the button, then HDR mode is engaged:



If the button is NOT lit, then tuner mode is engaged and HDR mode is disabled:



In HDR mode, the LO display is removed from the Main Spectrum Panel and the LO LOCK is engaged. The centre frequency for a given HDR band cannot be changed.

To leave HDR mode, either press the lit band button (this will act like a ON/OFF toggle), select a different band button, type a frequency in the RX control panel or select a frequency in the memory panel, that is outside of the current viewable spectrum.

A list of the HDR bands can be found in section [10](#) of the user manual.

23 - Troubleshooting

If an application using an RSP crashes, the Windows API Service may not be informed that the tuner has been released and is therefore available when the application is restarted. If the Windows service does not recognise that the device is present, yet the device is present in the device manager, it may be necessary to restart the Windows API Service.

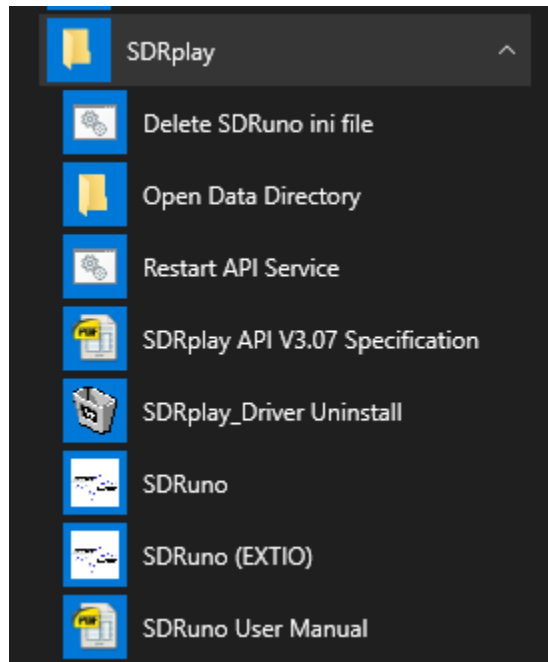

As of version 1.31 and beyond, this can be done from the Windows Start Menu by navigating to the SDRuno installation directory and selecting “Restart API Service”

From V1.31, SDRuno will create an error log file (%appdata%\SDRplay\error.log) if an error is caught and can be used by the SDRplay software team to identify potential issues.

From V1.33 there are new OPT Menu entries that could help in troubleshooting. “Open Data Directory in Explorer” will open an explorer window in the data directory where the ini and log files are created. “Open Previous Session’s Log File” will open the previous session’s log file in a notepad window. There is also a Windows Start Menu entry to open the Data Directory in an Explorer Window.

From V1.42 0720 there is a new OPT Menu entry that will open an Explorer Window in the Bug Reports Directory – “Open Bug Report Directory in Explorer”

Also starting in V1.42 0720 is a system for capturing application crashes into a file that can be sent to us via our ticket system for analysis. Use the “Open Bug Reports Directory in Explorer” OPT menu option which will open a windows explorer window showing the bug report files. These can then be attached to a support ticket and will allow us to analysis the crash in detail.

24 - Quick Start Guide

This quick start guide is a basic how-to. Please continue to consult the SDRuno manual for advanced operations. This guide assumes you have no prior experience using SDRuno or an RSP Software Defined Radio Receiver. It is assumed that you have successfully installed SDRuno.

Starting the data stream (powering on).

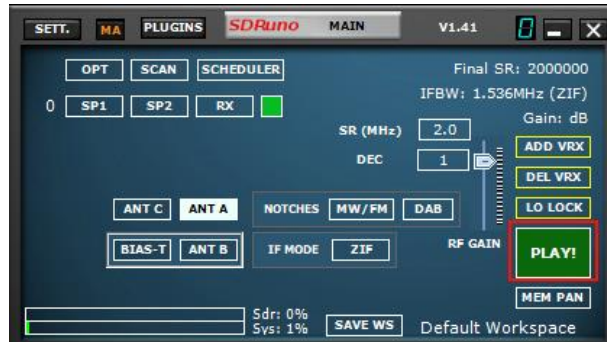

Clicking the PLAY button on the MAIN panel will start the data stream (power on).



Clicking the STOP button on the MAIN panel will stop the data stream (power down).

Antenna input selection.

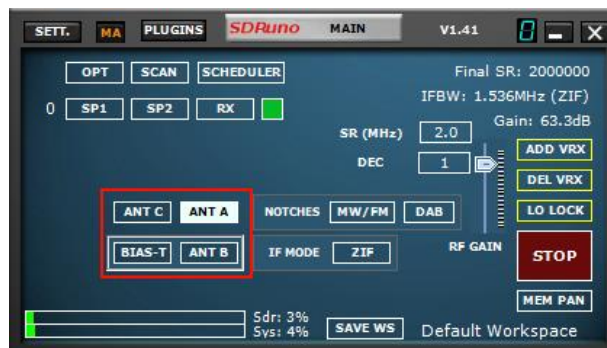

Depending on the model RSP (2/2pro, duo & dx) you can select different inputs for that device. Please be sure the correct input is selected within the MAIN panel and that your coax is terminated to that input on the device. The RSP1 and RSP1A have a single input so no input selection buttons will appear.

Note: Device inputs may have frequency limitations:

The RSP2/2pro and RSPduo HI-Z input is available (selectable) from 1kHz – 30MHz.

The RSPdx input C input is available (selectable) from 1 kHz – 200MHz. All other inputs (SMA) can tune across the full device receive range 1kHz– 2GHz

Adjusting the RF GAIN

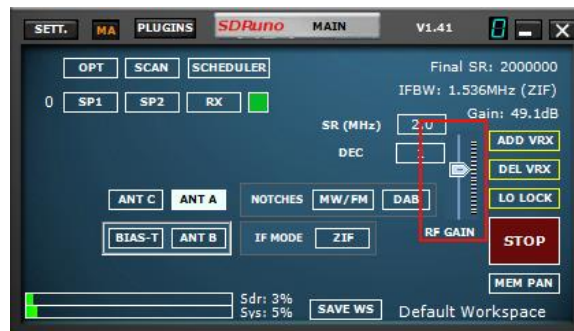

The RF GAIN slider should be placed at maximum or as close to maximum as possible unless an OVERLOAD warning message is displayed. If an OVERLOAD message appears, lower the RF GAIN slider until the OVERLOAD message is no longer displayed.

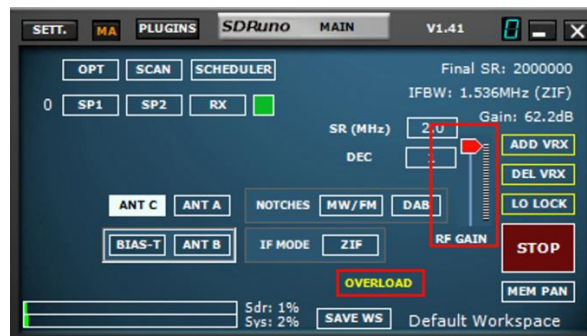

Tuning - Listening to FM broadcast or Medium Wave broadcast stations.

Tuning to FM broadcast or Medium Wave (AM) broadcast stations is recommended for new users to familiarize themselves with using SDRUno. FM and Medium Wave broadcast are usually very strong, allowing you to use the most basic of antennas. Select the AM or FM mode button as appropriate in RX Control then tune to the desired frequency in SDRUno via the frequency readout of the RX CONTROL panel:

Simply place your mouse cursor over the digit displayed and change the frequency digit using your mouse wheel up or down. An indicator will appear on the top of the digit that you can adjust using the mouse wheel.



Be sure the frequency you have entered is indeed your desired frequency. Note how the frequency is displayed in the RX CONTROL



At this point you should be seeing signals in the Waterfall and RF Spectrum windows and be hearing sounds through your speakers. You can adjust the volume using the Volume slider in RX Control and/or your Windows volume control. Refer to the User Manual (available via the OPT button in the Main Window) to help you adjust additional settings to optimize performance and explore the many features of SDRuno.





25 - Legal Information

For more information see
<https://www.sdrplay.com/>

For support see
<https://sdrplay.com/support/>

Redistribution and use in source and binary forms, with or without modification, are permitted provided that the following conditions are met:

1. Redistributions of source code must retain the above copyright notice, this list of conditions and the following disclaimer.
2. Redistributions in binary form must reproduce the above copyright notice, this list of conditions and the following disclaimer in the documentation and/or other materials provided with the distribution.
3. Neither the name of the copyright holder nor the names of its contributors may be used to endorse or promote products derived from this software without specific prior written permission.

THIS SOFTWARE IS PROVIDED BY THE COPYRIGHT HOLDERS AND CONTRIBUTORS "AS IS" AND ANY EXPRESS OR IMPLIED WARRANTIES, INCLUDING, BUT NOT LIMITED TO, THE IMPLIED WARRANTIES OF MERCHANTABILITY AND FITNESS FOR A PARTICULAR PURPOSE ARE DISCLAIMED. IN NO EVENT SHALL THE COPYRIGHT HOLDER OR CONTRIBUTORS BE LIABLE FOR ANY DIRECT, INDIRECT, INCIDENTAL, SPECIAL, EXEMPLARY, OR CONSEQUENTIAL DAMAGES (INCLUDING, BUT NOT LIMITED TO, PROCUREMENT OF SUBSTITUTE GOODS OR SERVICES; LOSS OF USE, DATA, OR PROFITS; OR BUSINESS INTERRUPTION) HOWEVER CAUSED AND ON ANY THEORY OF LIABILITY, WHETHER IN CONTRACT, STRICT LIABILITY, OR TORT (INCLUDING NEGLIGENCE OR OTHERWISE) ARISING IN ANY WAY OUT OF THE USE OF THIS SOFTWARE, EVEN IF ADVISED OF THE POSSIBILITY OF SUCH DAMAGE.

SDRplay modules use a Mirics chipset and software. The information supplied hereunder is provided to you by SDRplay under license from Mirics. Mirics hereby grants you a perpetual, worldwide, royalty free license to use the information herein for the purpose of designing software that utilizes SDRplay modules, under the following conditions:

There are no express or implied copyright licenses granted hereunder to design or fabricate any integrated circuits or integrated circuits based on the information in this document. Mirics reserves the right to make changes without further notice to any of its products. Mirics makes no warranty, representation or guarantee regarding the suitability of its products for any particular purpose, nor does Mirics assume any liability arising out of the application or use of any product or circuit, and specifically disclaims any and all liability, including without limitation consequential or incidental damages. Typical parameters that may be provided in Mirics data sheets and/or specifications can and do vary in different applications and actual performance may vary over time. All operating parameters must be validated for each customer application by the buyer's technical experts. SDRplay and Mirics products are not designed, intended, or authorized for use as components in systems intended for surgical implant into the body, or other applications intended to support or sustain life, or for any other application in which the failure of the Mirics product could create a situation where personal injury or death may occur. Should Buyer purchase or use SDRplay or Mirics products for any such unintended or unauthorized application, Buyer shall indemnify and hold both SDRplay and Mirics and their officers, employees, subsidiaries, affiliates, and distributors harmless against all claims, costs, damages, and expenses, and reasonable attorney fees arising out of, directly or indirectly, any claim of personal injury or death associated with such unintended or unauthorized use, even if such claim alleges that either SDRplay or Mirics were negligent regarding the design or manufacture of the part. Mirics FlexiRF™, Mirics FlexiTV™ and Mirics™ are trademarks of Mirics.

SDRplay is the trading name of SDRplay Limited a company registered in England # 09035244.
Mirics is the trading name of Mirics Limited a company registered in England # 05046393